

NOTLAR:

1-(*) İşaretili giriş/çıkışlar L-ION EP33 modelinde yoktur.

2-Röle çıkışlar 24VAC 5A'dır.



TEL: 0216 527 98 70
 FAX: 0216 527 98 71
 INTERNET: www.ontrol.com.tr

PROJE

ONTROL A.Ş

SİSTEM

Senaryo Tip 1
 L-ION EP 44

TARİH 23.11.2018

REV.NO R02

ÇİZEN AYSUN VAYIÇ

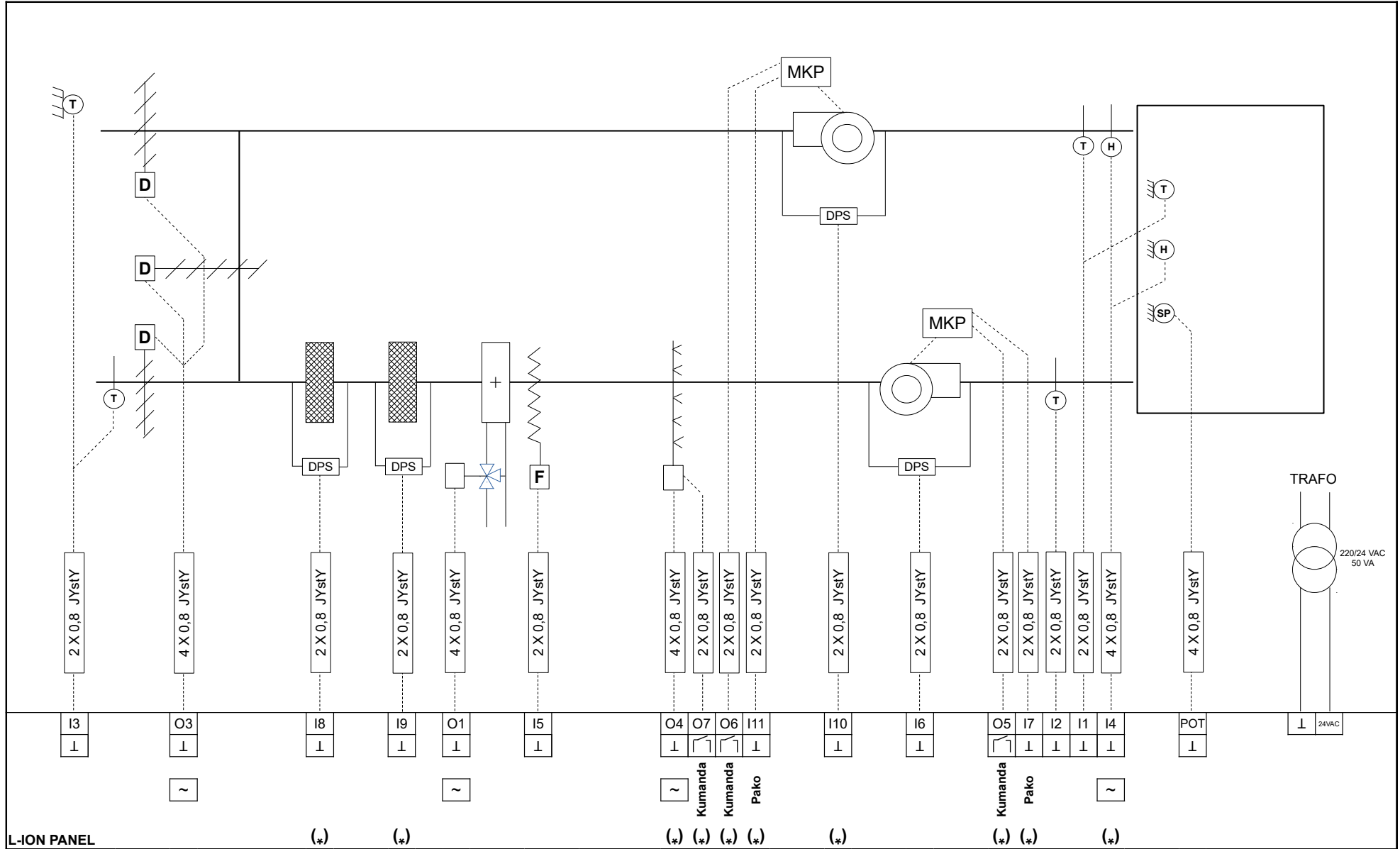

L-ION PANEL

NOTLAR:

1-(*) İşaretili giriş/çıkışlar L-ION EP33 modelinde yoktur.

2-Röle çıkışlar 24VAC 5A'dir.



TEL: 0216 527 98 70
FAX: 0216 527 98 71
INTERNET: www.ontrol.com.tr

PROJE

ONTROL A.Ş

SİSTEM

Senaryo Tip 2
L-ION EP 44

TARİH 23.11.2018

REV.NO R02

ÇİZEN AYSUN VAYIÇ

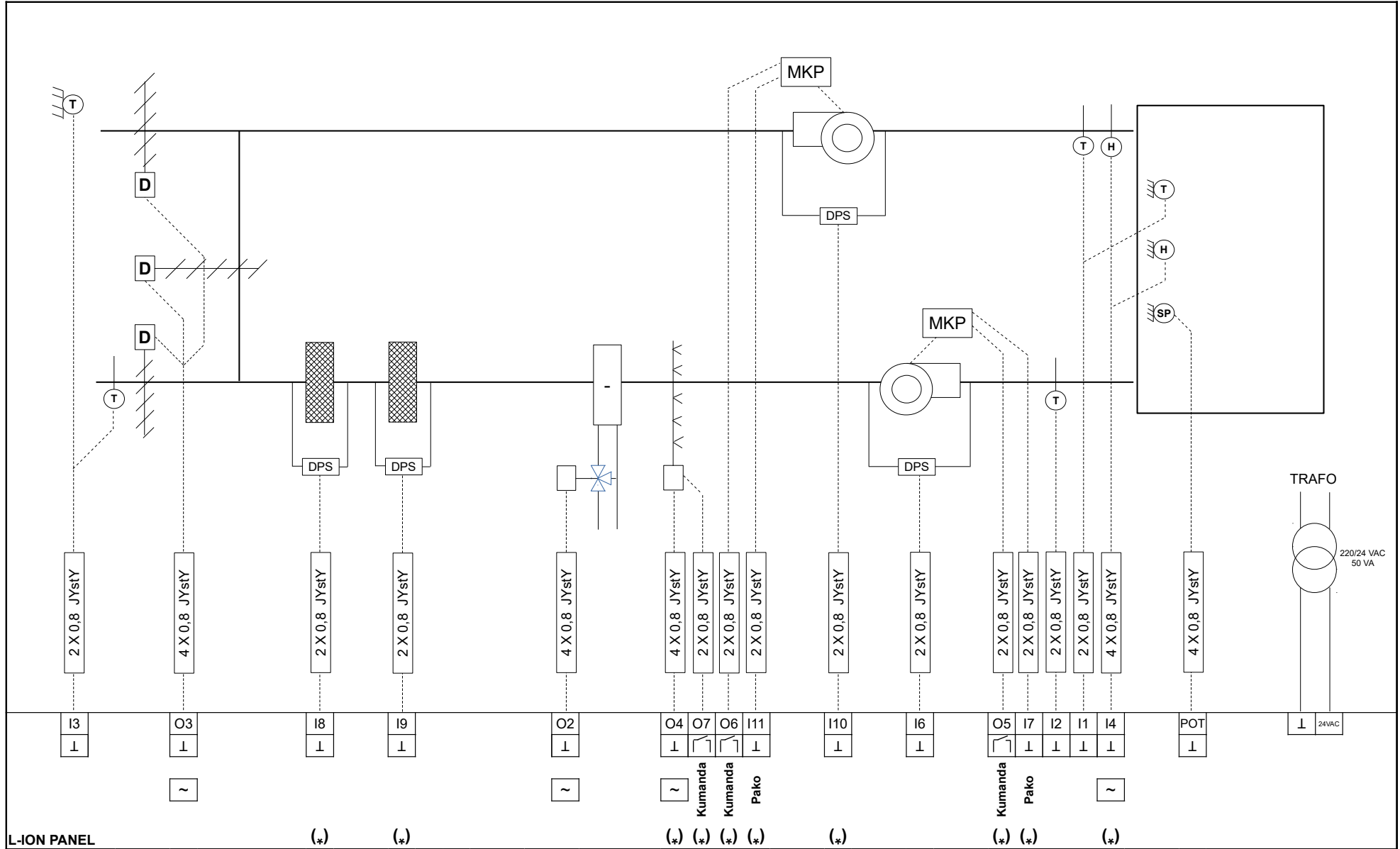

L-ION PANEL

NOTLAR :

1-(*) İşaretili giriş/çıkışlar L-ION EP33 modelinde yoktur.

2-Röle çıkışlar 24VAC 5A'dır.



TEL: 0216 527 98 70
 FAX: 0216 527 98 71
 INTERNET: www.ontrol.com.tr

PROJE

ONTROL A.Ş

SİSTEM

**Senaryo Tip 3
 L-ION EP 44**

TARİH 23.11.2018

REV.NO R02

ÇİZEN AYŞUN VAYIÇ

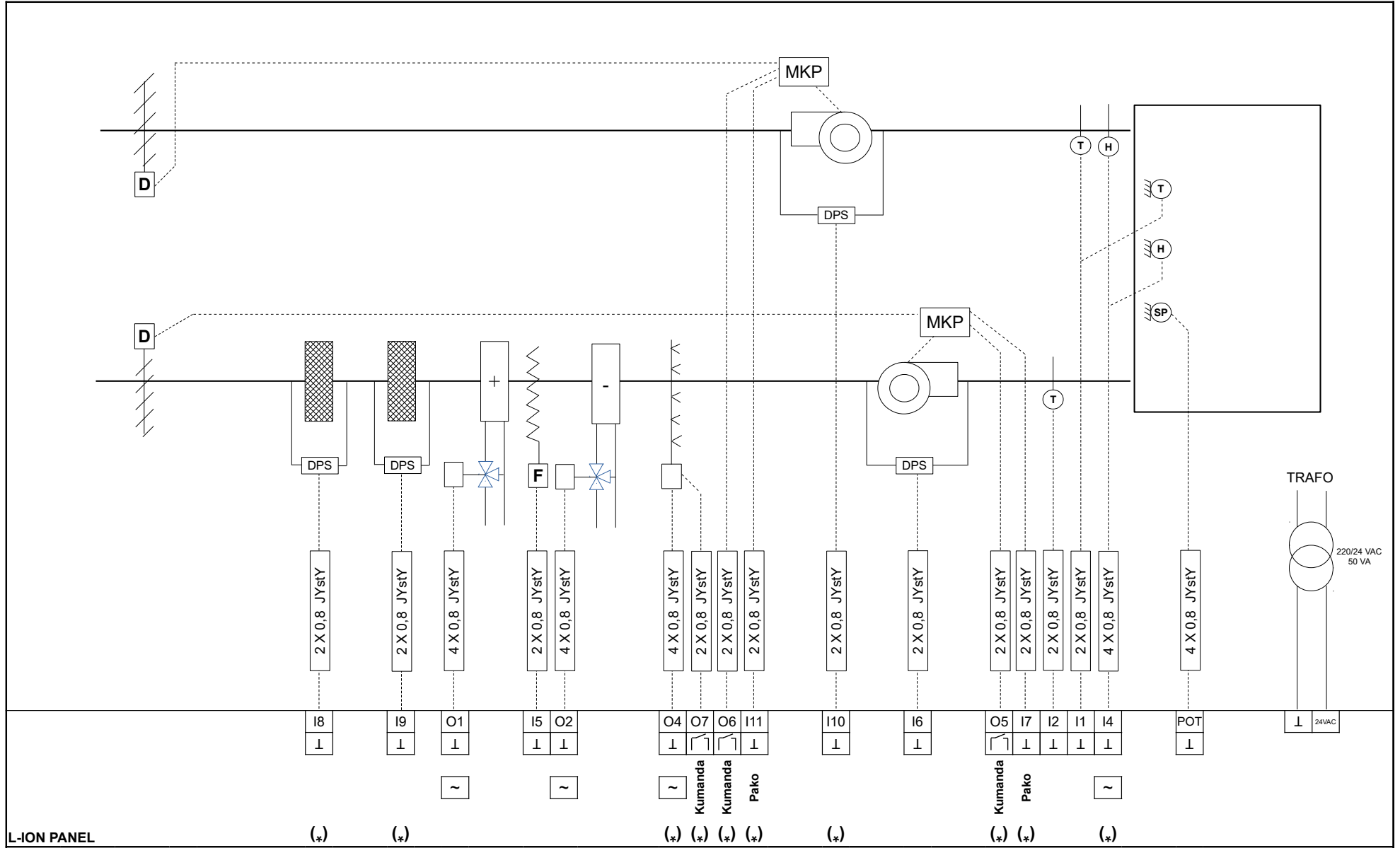

L-ION PANEL

(*)

(*)

(*)

(*)

(*)

(*)

(*)

(*)

(*)

(*)

NOTLAR :

1- (*) İşaretili giriş/çıkışlar L-ION EP33 modelinde yoktur.

2-Röle çıkışlar 24VAC 5A'dır.



TEL: 0216 527 98 70
 FAX: 0216 527 98 71
 INTERNET: www.ontrol.com.tr

PROJE

ONTROL A.Ş

SİSTEM

Senaryo Tip 4
 L-ION EP 44

TARİH 23.11.2018

REV.NO R02

ÇİZEN AYŞUN VAYIÇ

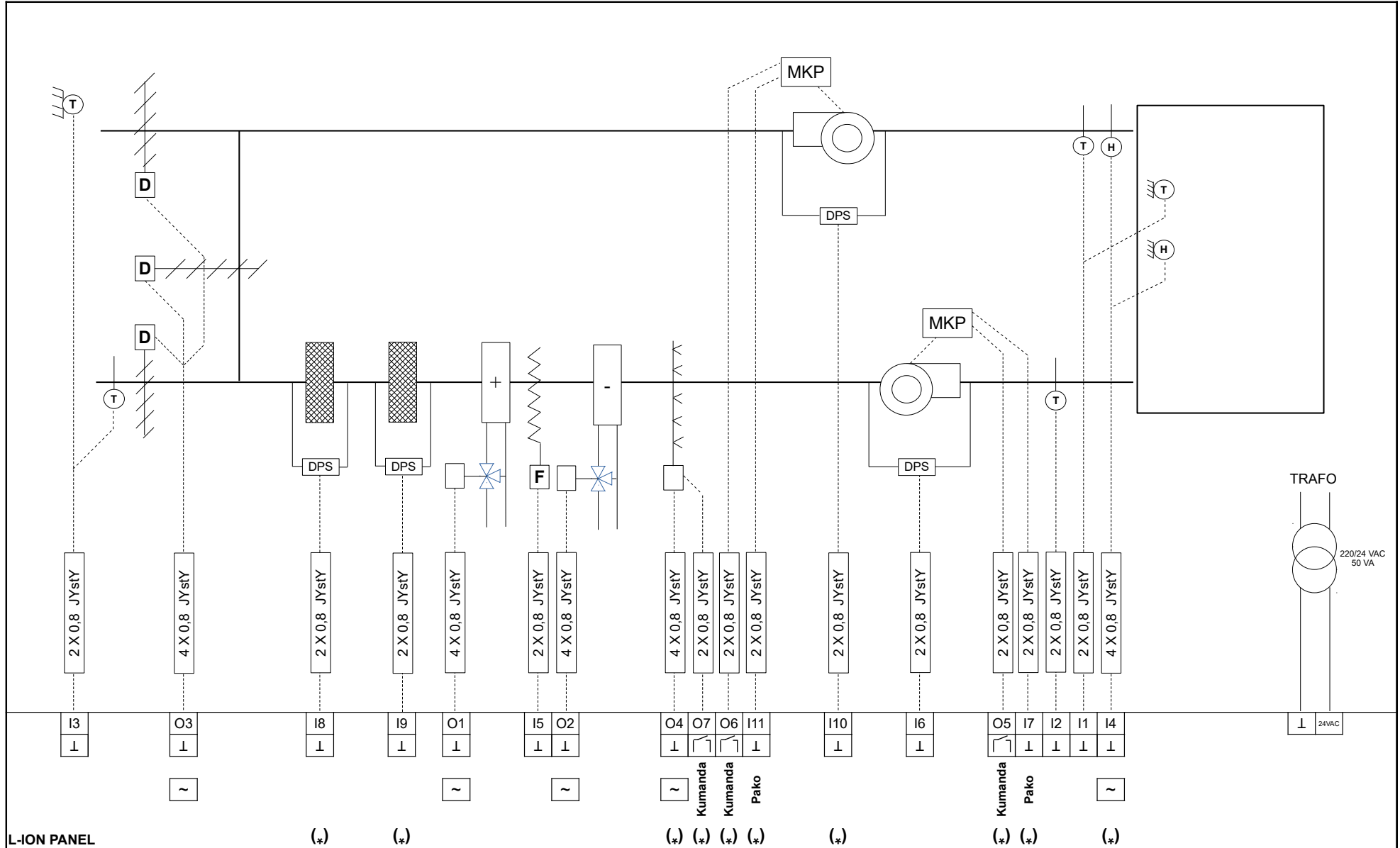

NOTLAR :

1-(*) İşaretili giriş/çıkışlar L-ION EP33 modelinde yoktur.

2-Röle çıkışlar 24VAC 5A'dir.

	TEL: 0216 527 98 70	PROJE	SİSTEM	TARİH	23.11.2018
	FAX: 0216 527 98 71	ONTROL A.Ş	Senaryo Tip 5	REV.NO	R02
	INTERNET: www.ontrol.com.tr		L-ION EP 44	ÇİZEN	AYSUN VAYIÇ

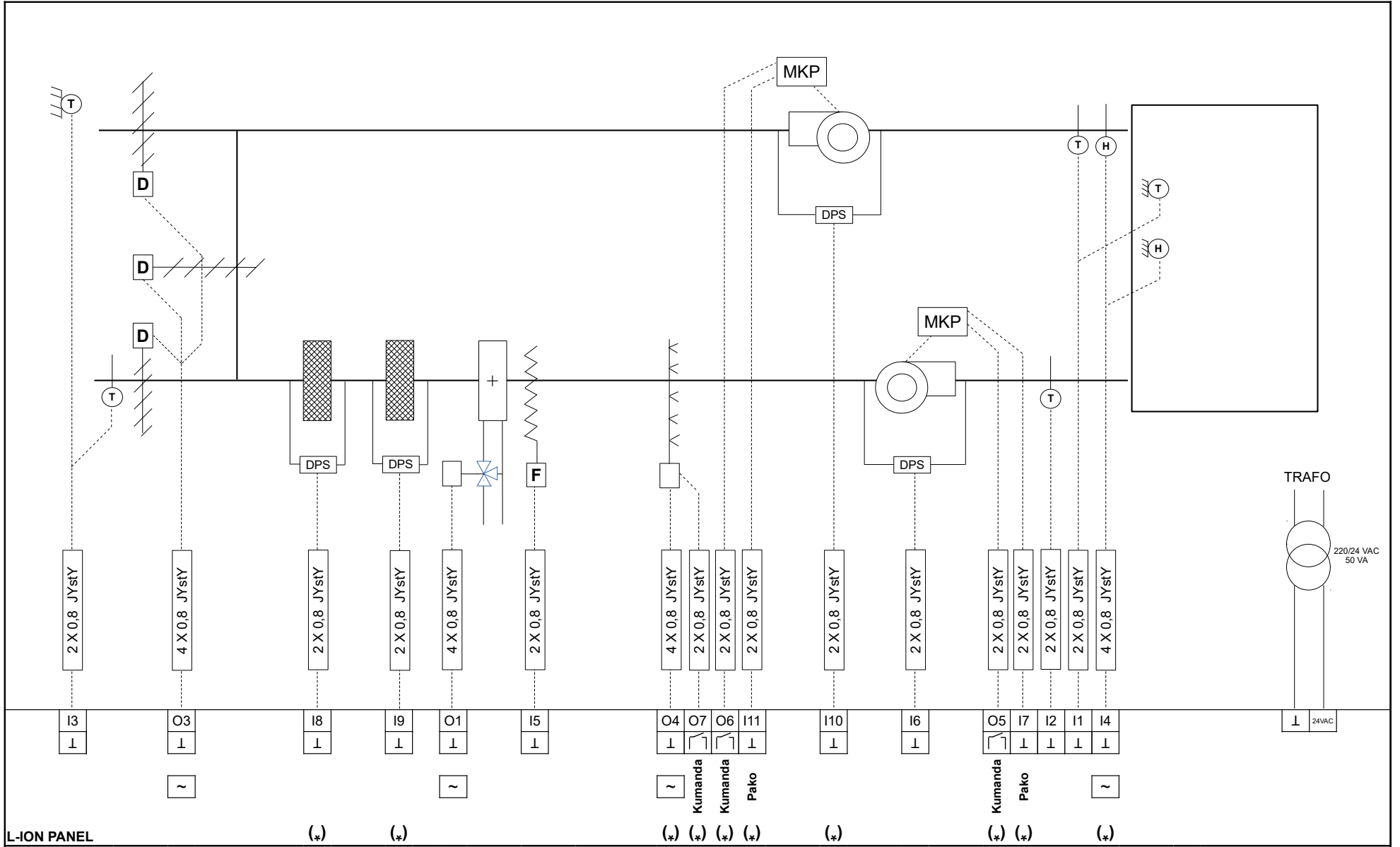

TEL: 0216 527 98 70
 FAX: 0216 527 98 71
 INTERNET: www.ontrol.com.tr

PROJE

ONTROL A.Ş

SİSTEM

Senaryo Tip 6
 L-ION EP 44

TARİH 23.11.2018

REV.NO R02

ÇİZEN AYŞUN VAYIÇ

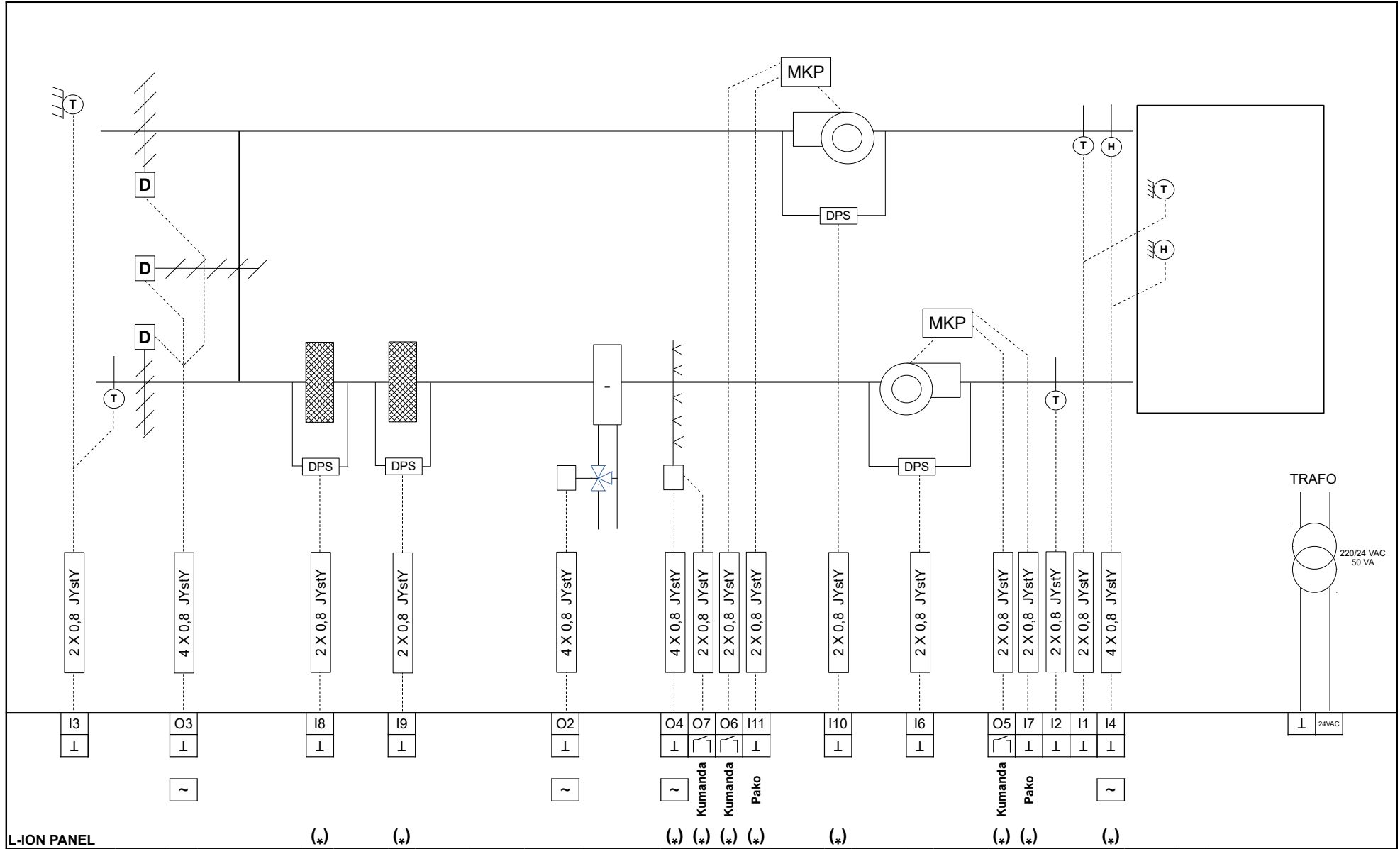

NOTLAR :

1-(*) İşaretili giriş/çıkışlar L-ION EP33 modelinde yoktur.

2-Röle çıkışlar 24VAC 5A'dir.



TEL: 0216 527 98 70
 FAX: 0216 527 98 71
 INTERNET: www.ontrol.com.tr

PROJE

ONTROL A.Ş

SİSTEM

Senaryo Tip 7
 L-ION EP 44

TARİH 23.11.2018

REV.NO R02

ÇİZEN AYSUN VAYIÇ

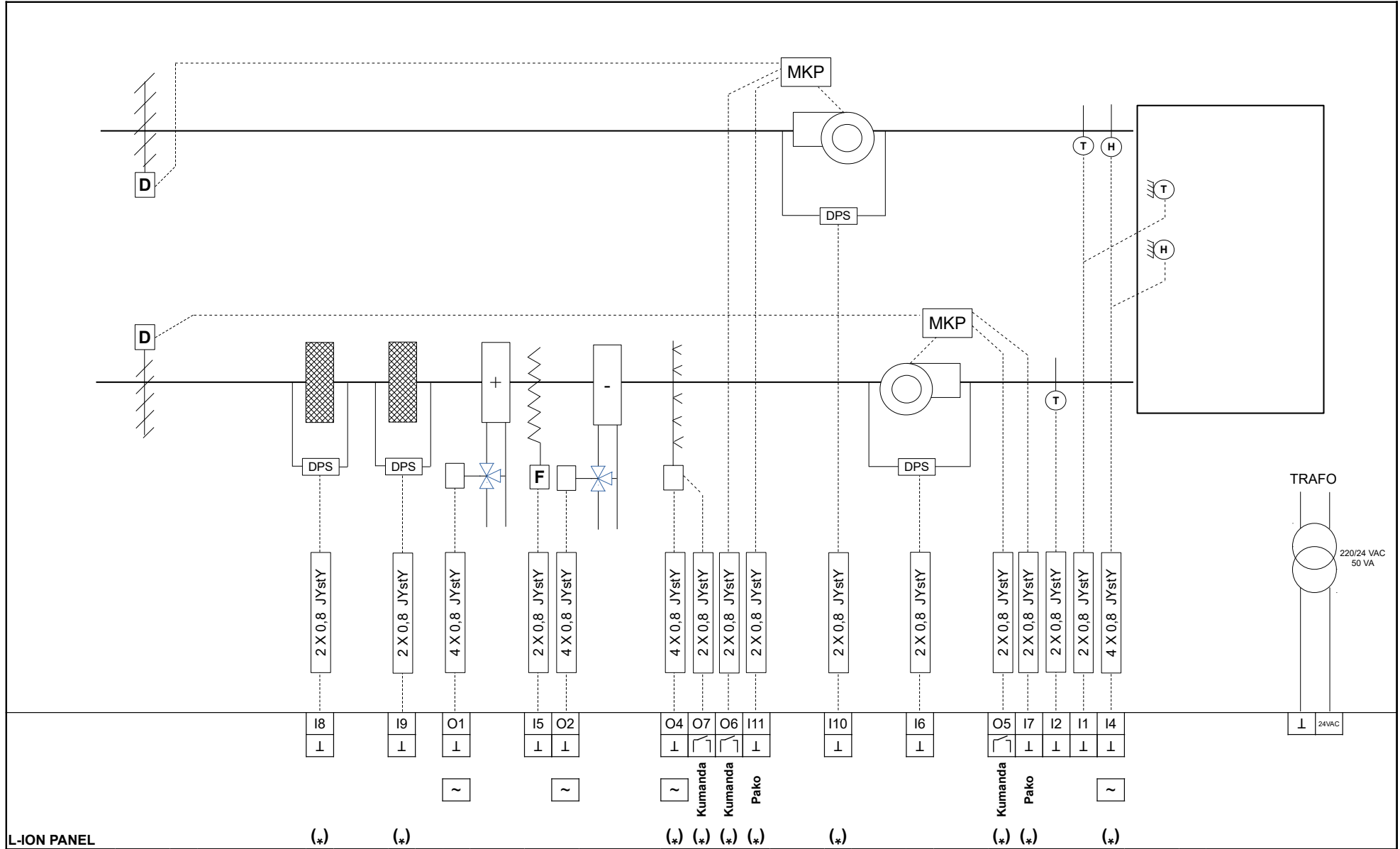

L-ION PANEL

NOTLAR :

1-(*) İşaretili giriş/çıkışlar L-ION EP33 modelinde yoktur.

2-Röle çıkışlar 24VAC 5A'dir.



TEL: 0216 527 98 70
 FAX: 0216 527 98 71
 INTERNET: www.ontrol.com.tr

PROJE
ONTROL A.Ş

SİSTEM
**Senaryo Tip 8
 L-ION EP 44**

TARİH: 23.11.2018
 REV.NO: R02
 ÇİZEN: AYSUN VAYIÇ

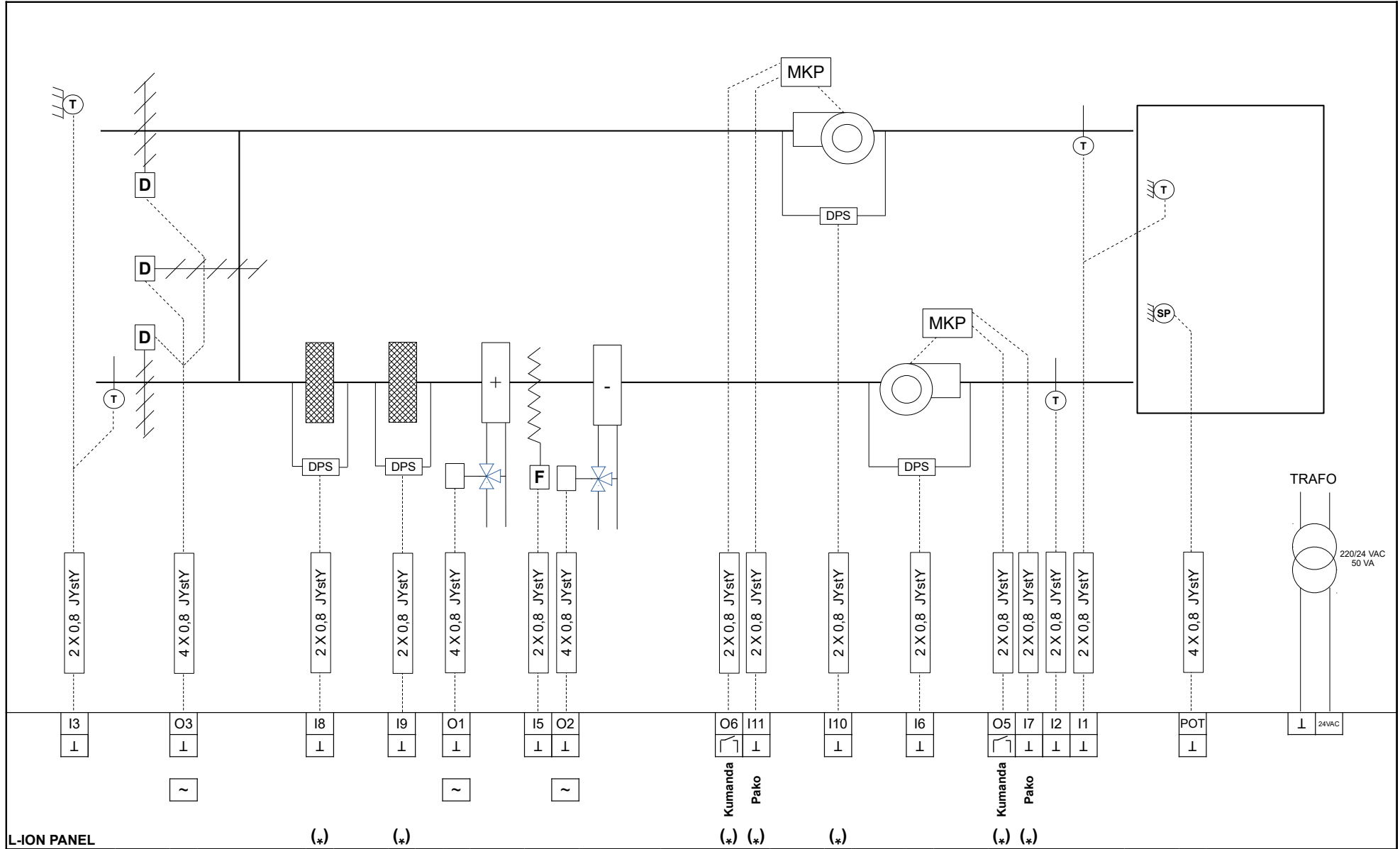

L-ION PANEL

NOTLAR :

1-(*) İşaretili giriş/çıkışlar L-ION EP33 modelinde yoktur.

2-Röle çıkışlar 24VAC 5A'dır.



TEL: 0216 527 98 70
 FAX: 0216 527 98 71
 INTERNET: www.ontrol.com.tr

PROJE
ONTROL A.Ş

SİSTEM
**Senaryo Tip 9
 L-ION EP 44**

TARİH: 23.11.2018
 REV.NO: R02
 ÇİZEN: AYSUN VAYIÇ

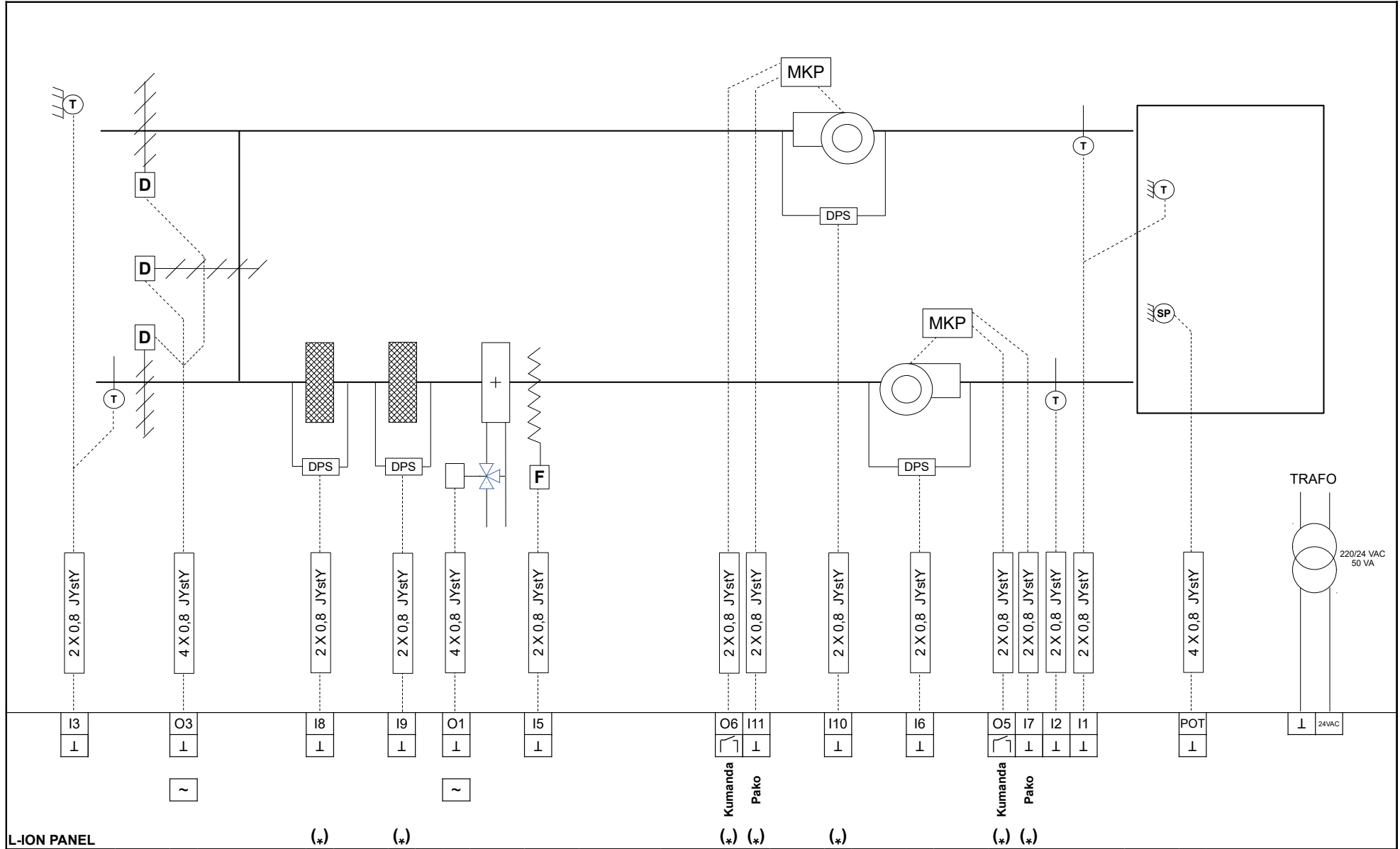

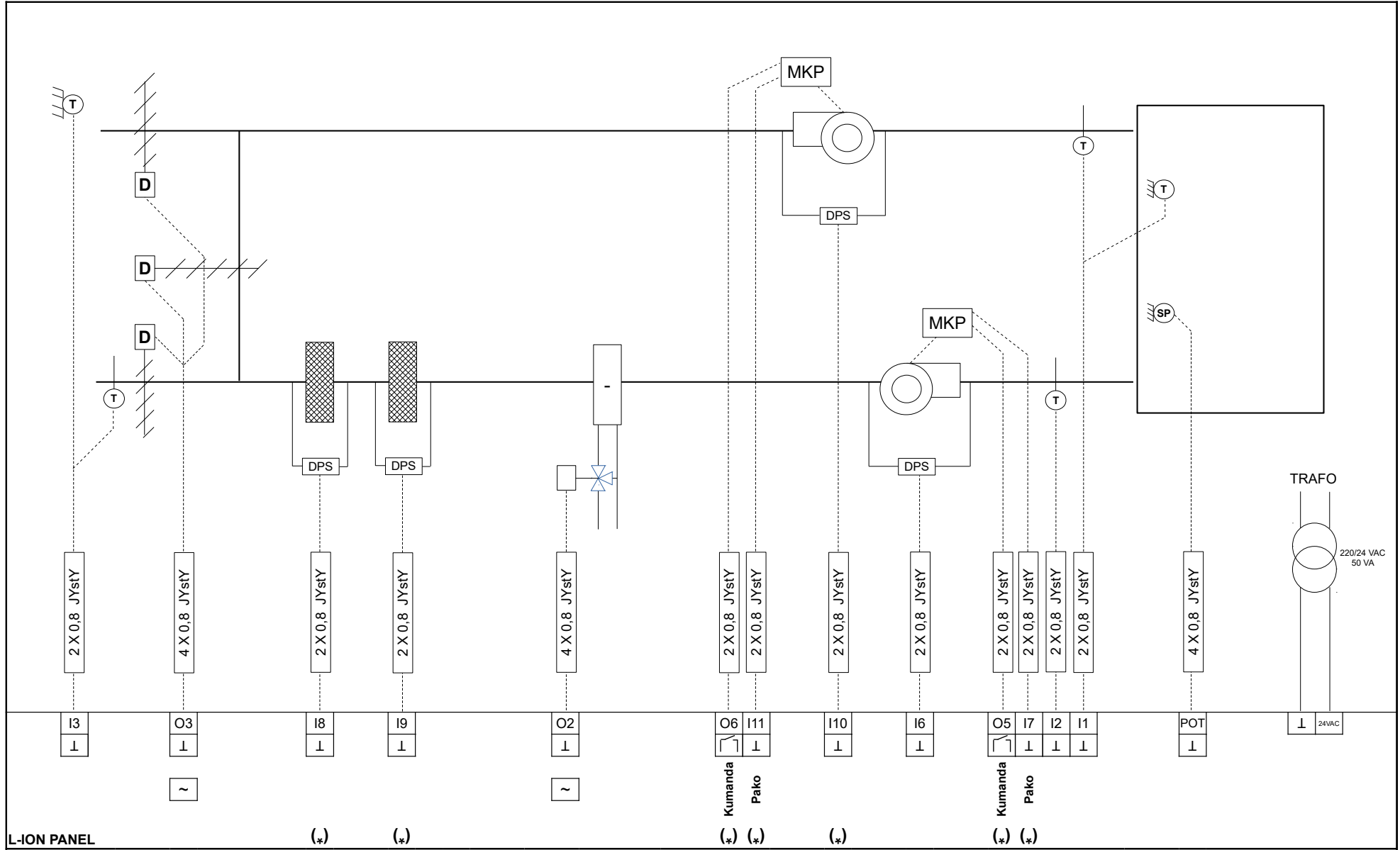

NOTLAR :

1-(*) İşaretili giriş/çıkışlar L-ION EP33 modelinde yoktur.

2-Röle çıkışlar 24VAC 5A'dir.



TEL: 0216 527 98 70
 FAX: 0216 527 98 71
 INTERNET: www.ontrol.com.tr

PROJE
ONTROL A.Ş

SİSTEM
**Senaryo Tip 11
 L-ION EP 44**

TARİH 23.11.2018
 REV.NO R02
 ÇİZEN AYSUN VAYIÇ

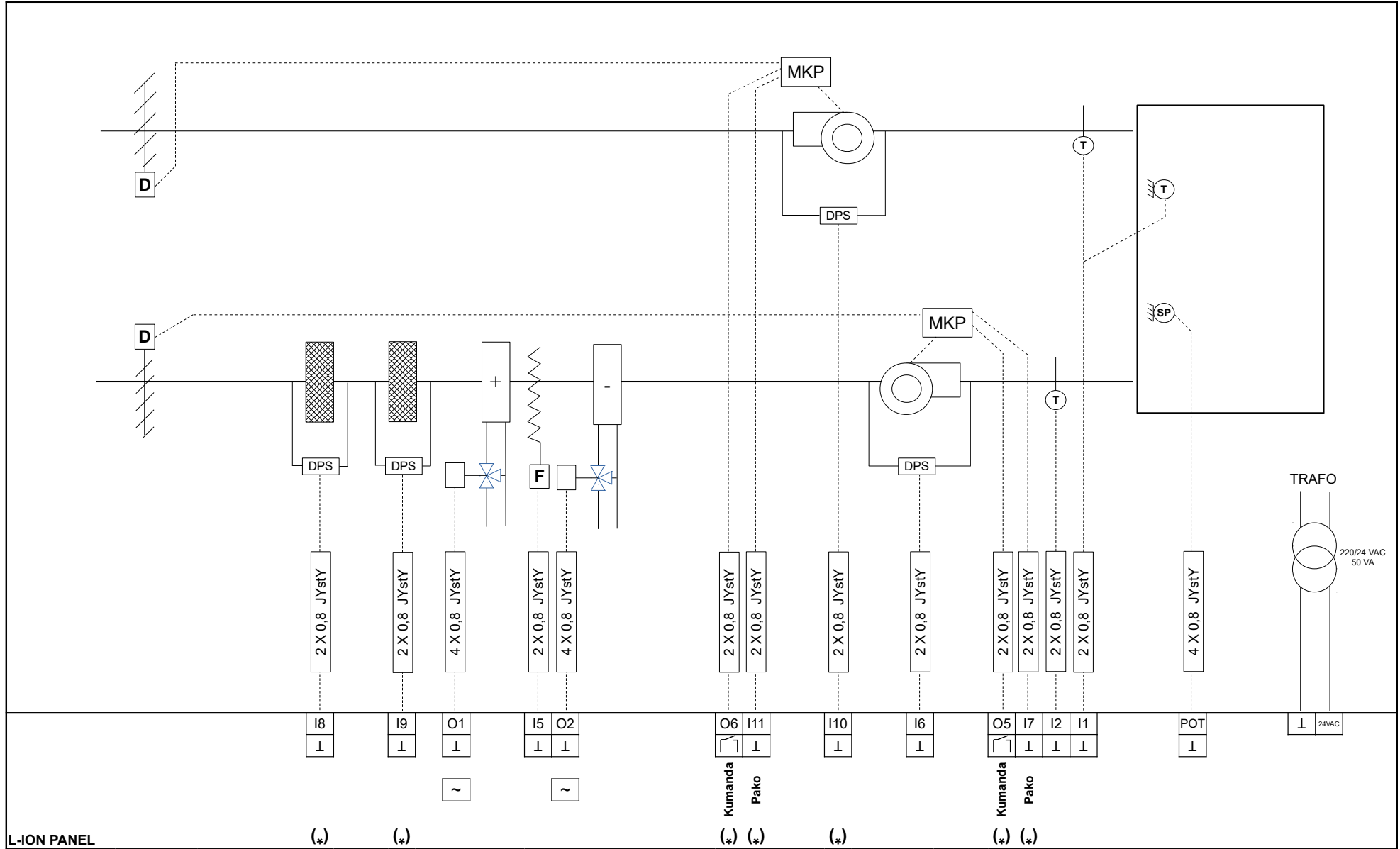

NOTLAR :

1-(*) İşaretili giriş/çıkışlar L-ION EP33 modelinde yoktur.

2-Röle çıkışlar 24VAC 5A'dir.



TEL: 0216 527 98 70
 FAX: 0216 527 98 71
 INTERNET: www.ontrol.com.tr

PROJE
ONTROL A.Ş

SİSTEM
**Senaryo Tip 12
 L-ION EP 44**

TARİH: 23.11.2018
 REV.NO: R02
 ÇİZEN: AYSUN VAYIÇ

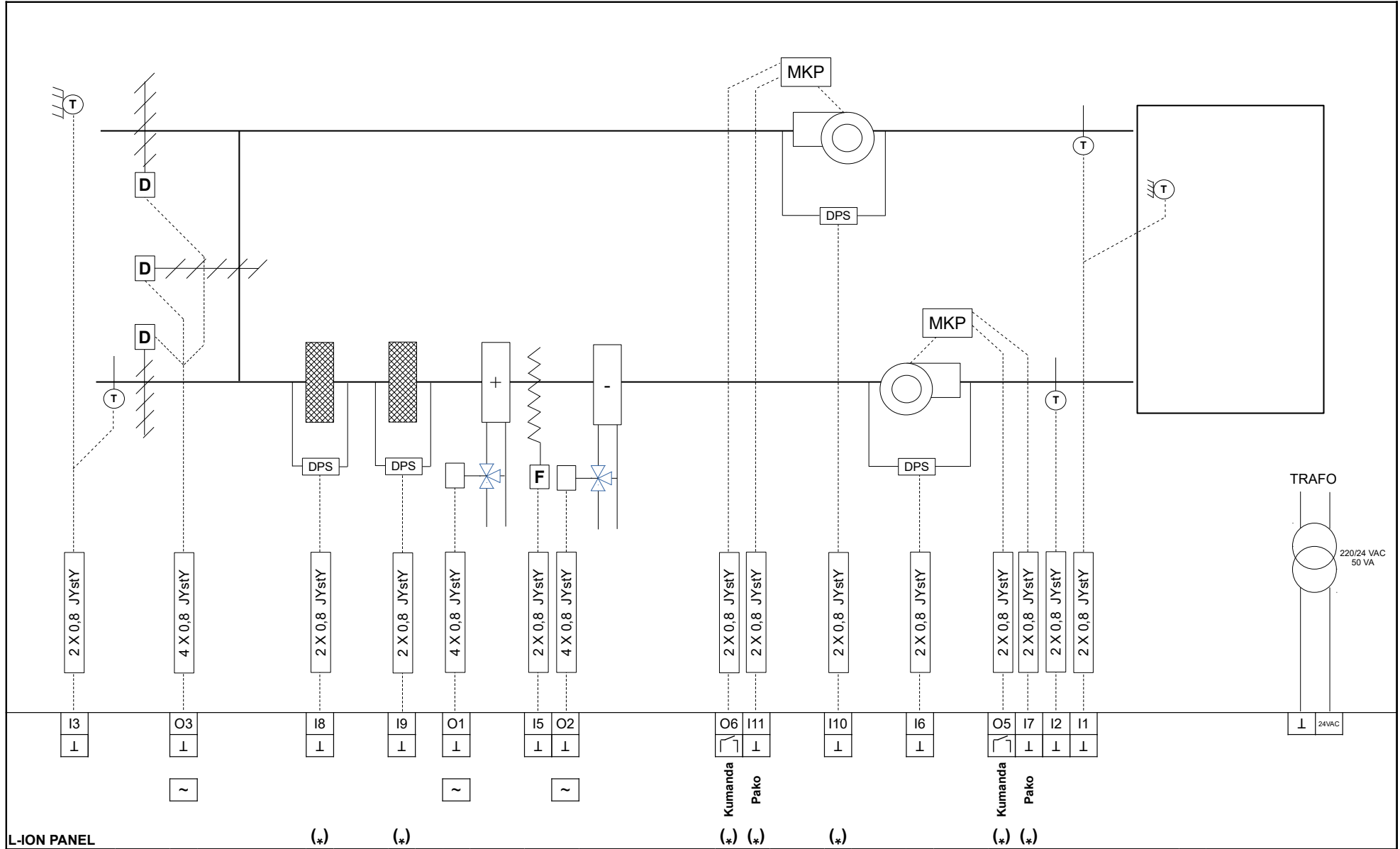

NOTLAR :

1-(*) İşaretili giriş/çıkışlar L-ION EP33 modelinde yoktur.

2-Röle çıkışlar 24VAC 5A'dir.



TEL: 0216 527 98 70
 FAX: 0216 527 98 71
 INTERNET: www.ontrol.com.tr

PROJE
ONTROL A.Ş

SİSTEM
**Senaryo Tip 13
 L-ION EP 44**

TARİH: 23.11.2018
 REV.NO: R02
 ÇİZEN: AYSUN VAYIÇ

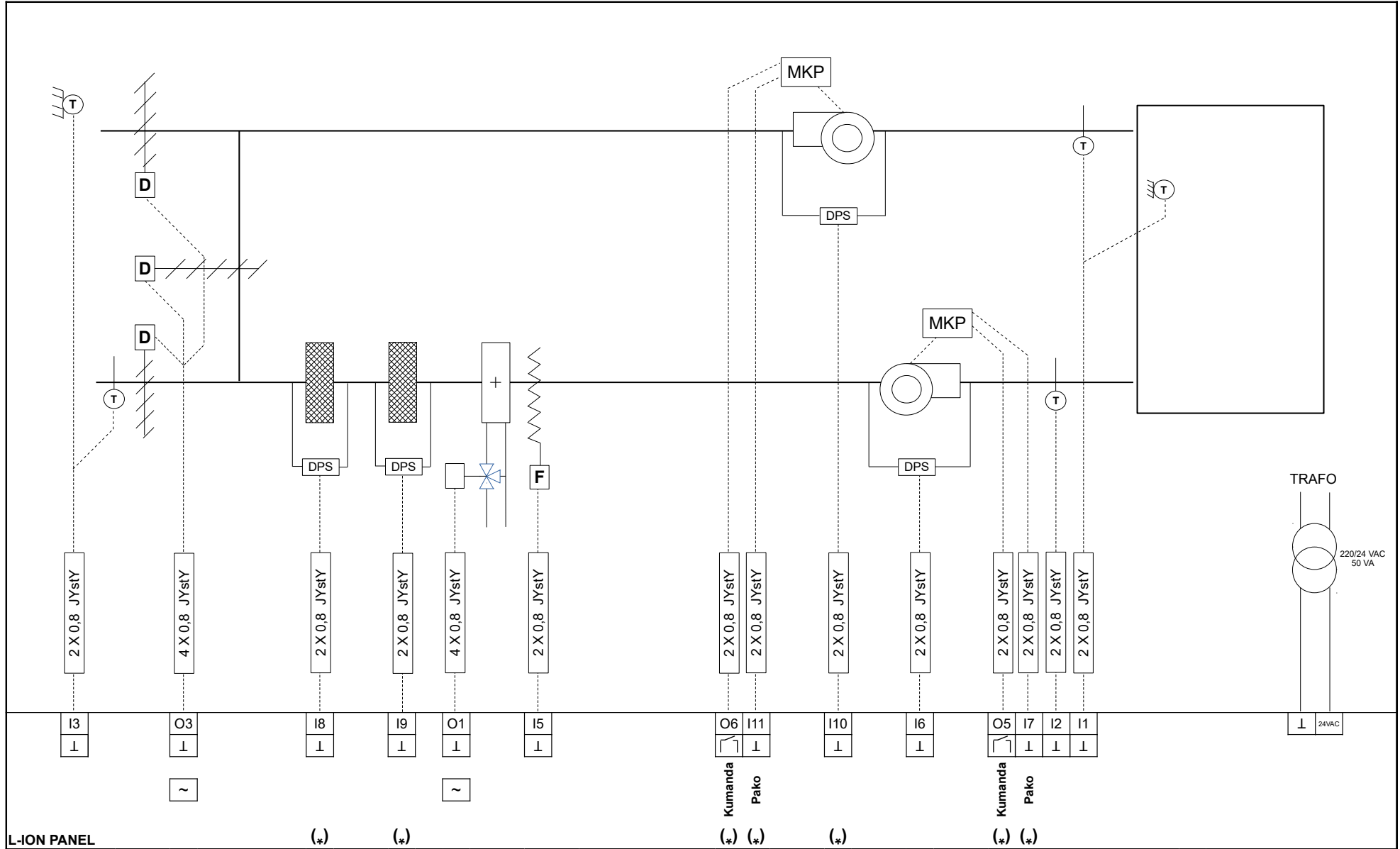

NOTLAR :

1-(*) İşaretili giriş/çıkışlar L-ION EP33 modelinde yoktur.

2-Röle çıkışlar 24VAC 5A'dir.



TEL: 0216 527 98 70
 FAX: 0216 527 98 71
 INTERNET: www.ontrol.com.tr

PROJE
ONTROL A.Ş

SİSTEM
**Senaryo Tip 14
 L-ION EP 44**

TARİH: 23.11.2018
 REV.NO: R02
 ÇİZEN: AYSUN VAYIÇ

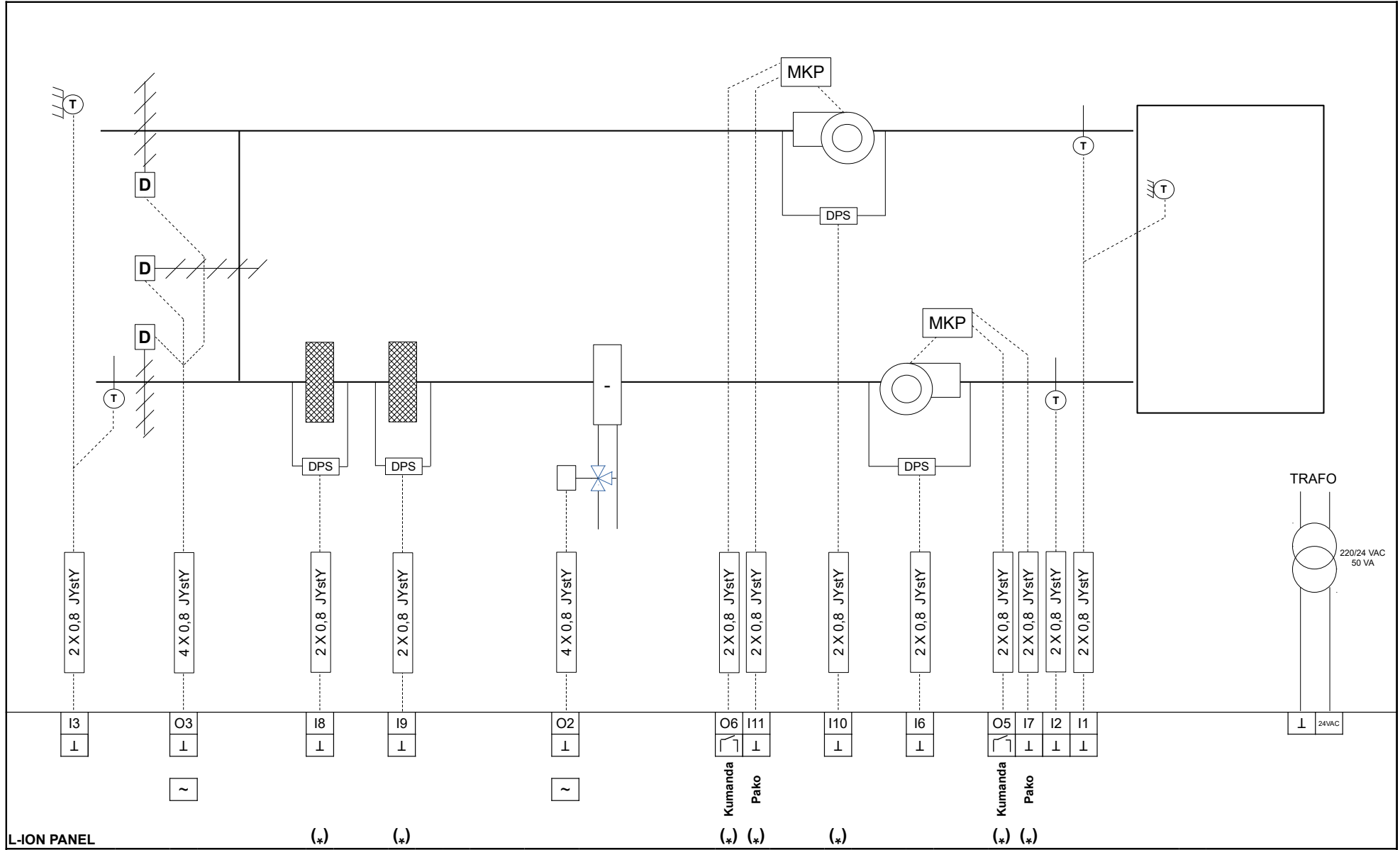

NOTLAR :

1-(*) İşaretili giriş/çıkışlar L-ION EP33 modelinde yoktur.

2-Röle çıkışlar 24VAC 5A'dir.



TEL: 0216 527 98 70
 FAX: 0216 527 98 71
 INTERNET: www.ontrol.com.tr

PROJE
ONTROL A.Ş

SİSTEM
**Senaryo Tip 15
 L-ION EP 44**

TARİH: 23.11.2018
 REV.NO: R02
 ÇİZEN: AYSUN VAYIÇ

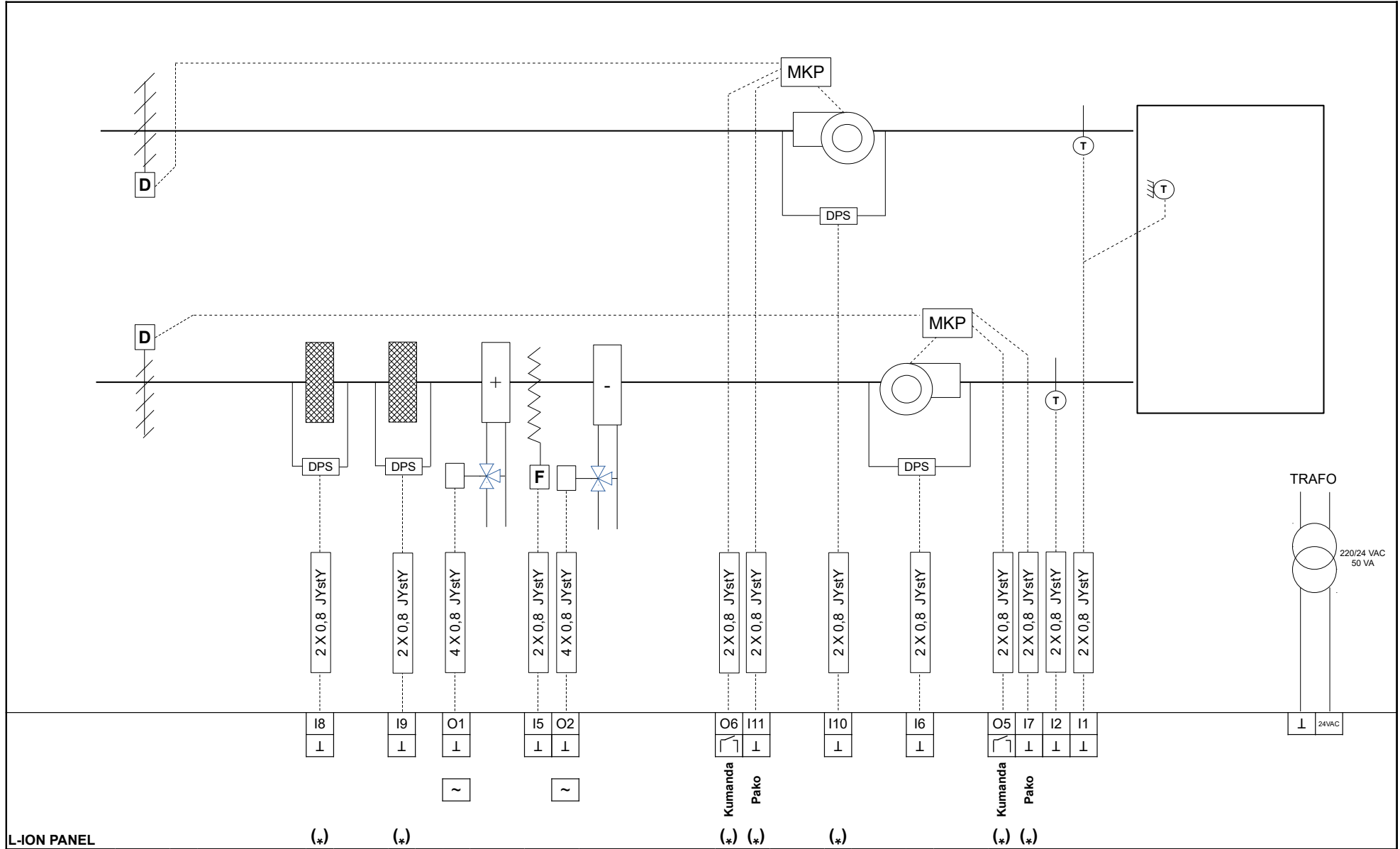

NOTLAR :

1-(*) İşaretili giriş/çıkışlar L-ION EP33 modelinde yoktur.

2-Röle çıkışlar 24VAC 5A'dır.



TEL: 0216 527 98 70
 FAX: 0216 527 98 71
 INTERNET: www.ontrol.com.tr

PROJE
ONTROL A.Ş

SİSTEM
**Senaryo Tip 16
 L-ION EP 44**

TARİH: 23.11.2018
 REV.NO: R02
 ÇİZEN: AYSUN VAYIÇ

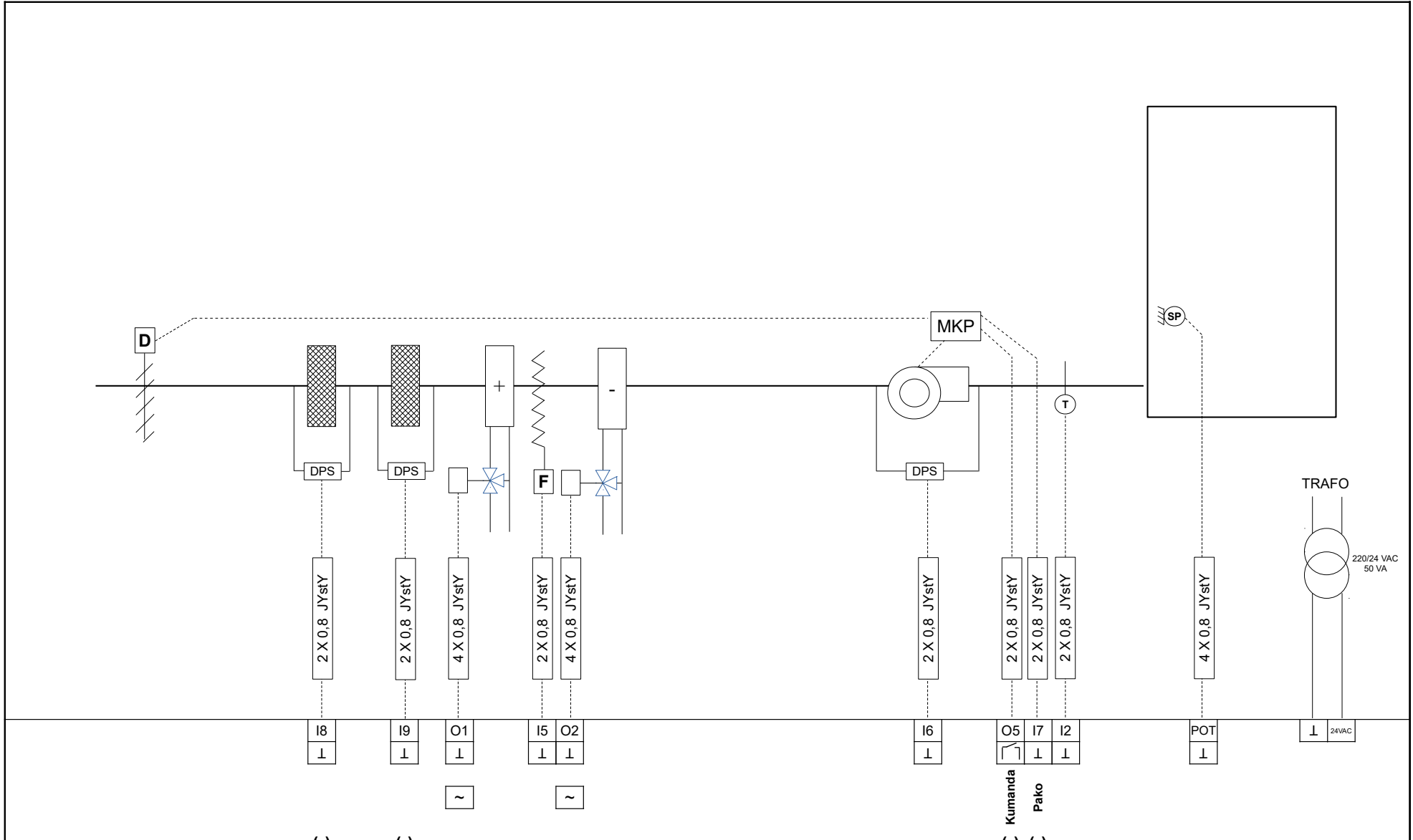

NOTLAR :

1-(*) İşaretili giriş/çıkışlar L-ION EP33 modelinde yoktur.

2-Röle çıkışlar 24VAC 5A'dır.



TEL: 0216 527 98 70
 FAX: 0216 527 98 71
 INTERNET: www.ontrol.com.tr

PROJE
ONTROL A.Ş

SİSTEM
**Senaryo Tip 17
 L-ION EP 44**

TARİH 23.11.2018
 REV.NO R02
 ÇİZEN AYSUN VAYIÇ

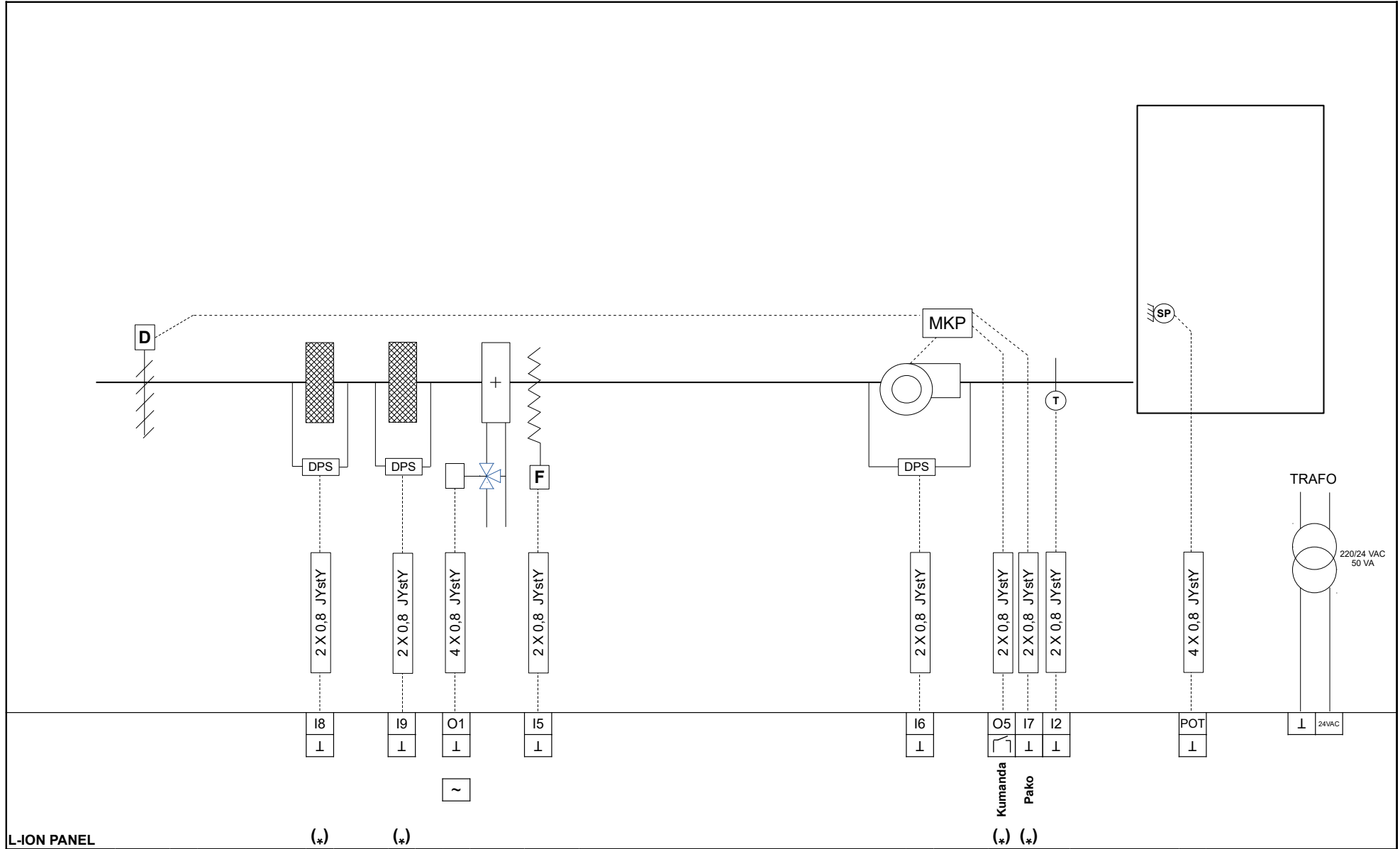

NOTLAR :

1-(*) İşaretili giriş/çıkışlar L-ION EP33 modelinde yoktur.

2-Röle çıkışlar 24VAC 5A'dır.



TEL: 0216 527 98 70
 FAX: 0216 527 98 71
 INTERNET: www.ontrol.com.tr

PROJE **ONTROL A.Ş**

SİSTEM **Senaryo Tip 18
 L-ION EP 44**

TARİH 23.11.2018
 REV.NO R02
 ÇİZEN AYSUN VAYIÇ

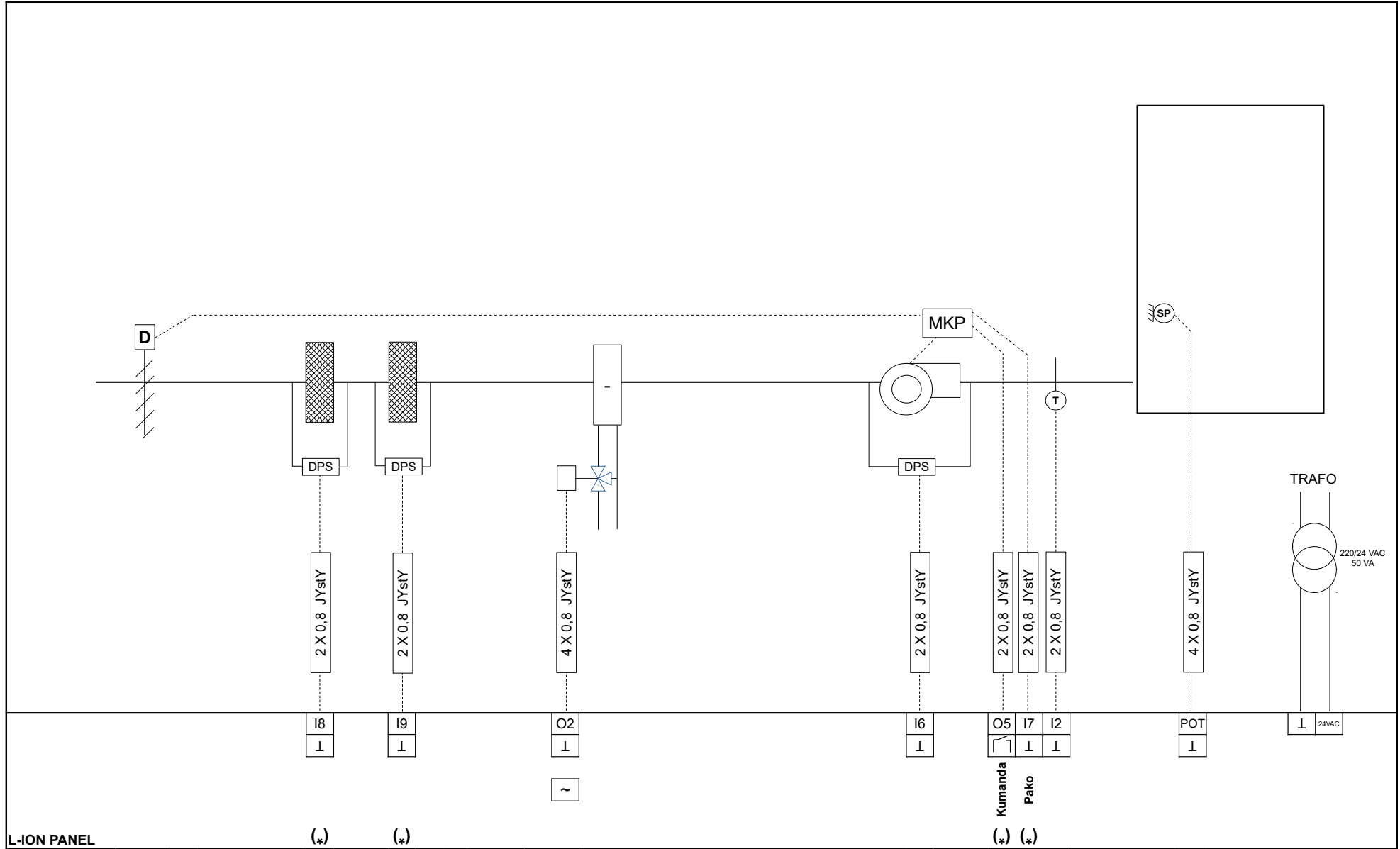

NOTLAR :

1-(*) İşaretili giriş/çıkışlar L-ION EP33 modelinde yoktur.

2-Röle çıkışlar 24VAC 5A'dir.



TEL: 0216 527 98 70
 FAX: 0216 527 98 71
 INTERNET: www.ontrol.com.tr

PROJE **ONTROL A.Ş**

SİSTEM **Senaryo Tip 19
 L-ION EP 44**

TARİH 23.11.2018
 REV.NO R02
 ÇİZEN AYSUN VAYIÇ

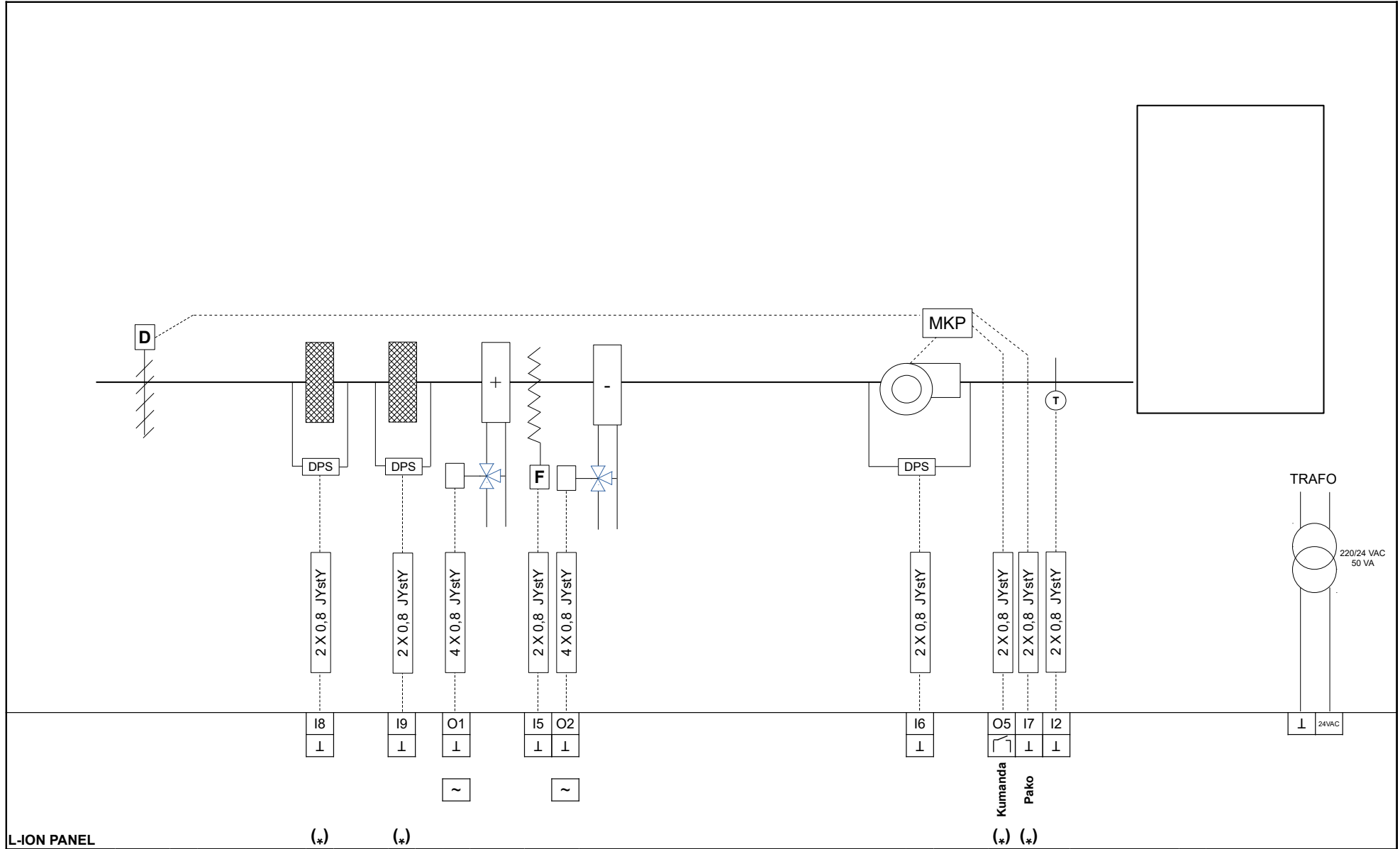

NOTLAR :

1-(*) İşaretili giriş/çıkışlar L-ION EP33 modelinde yoktur.

2-Röle çıkışlar 24VAC 5A'dır.



TEL: 0216 527 98 70
 FAX: 0216 527 98 71
 INTERNET: www.ontrol.com.tr

PROJE
ONTROL A.Ş

SİSTEM
**Senaryo Tip 20
 L-ION EP 44**

TARİH: 23.11.2018
 REV.NO: R02
 ÇİZEN: AYSUN VAYIÇ

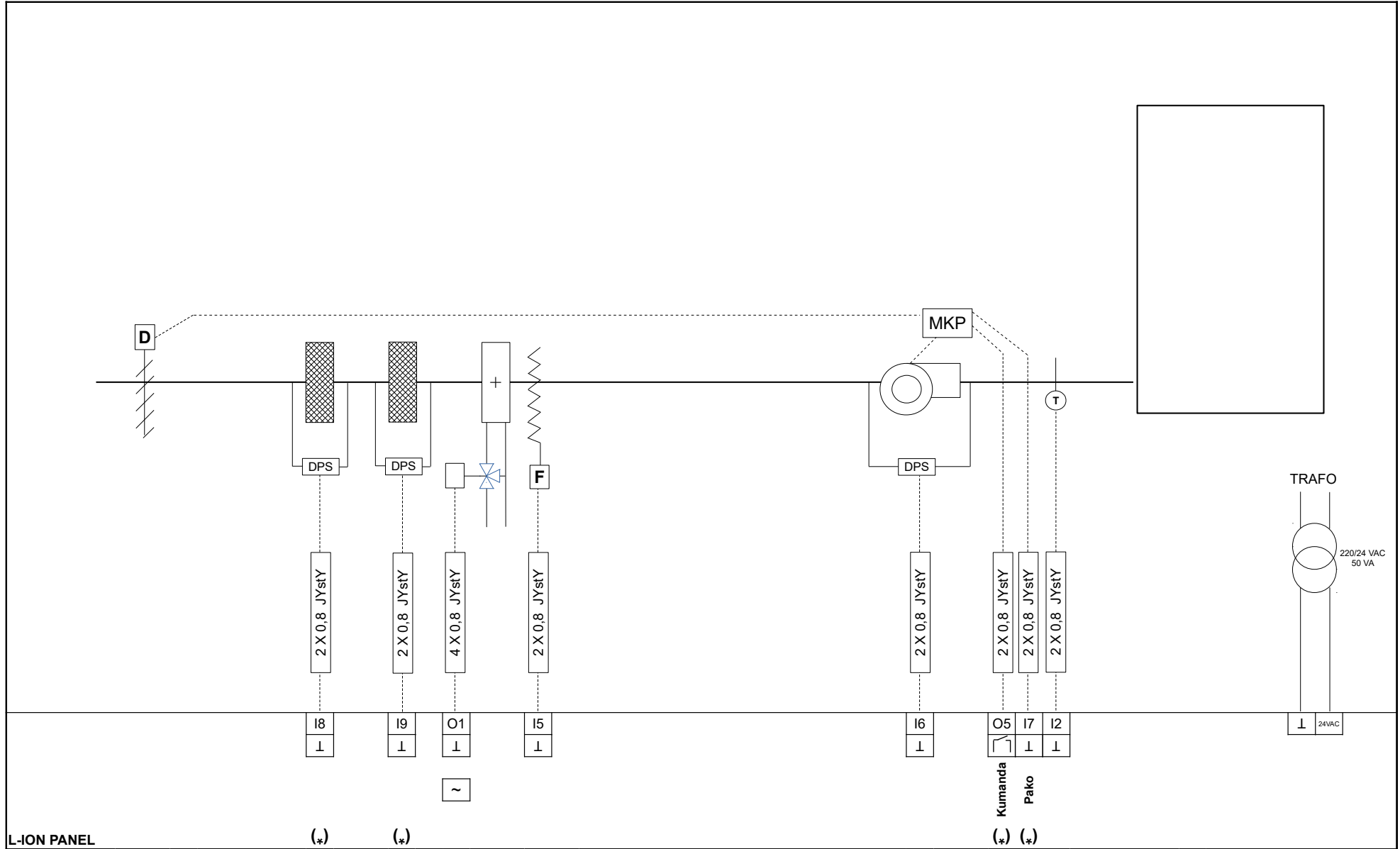

NOTLAR :

1-(*) İşaretili giriş/çıkışlar L-ION EP33 modelinde yoktur.

2-Röle çıkışlar 24VAC 5A'dır.



TEL: 0216 527 98 70
 FAX: 0216 527 98 71
 INTERNET: www.ontrol.com.tr

PROJE
ONTROL A.Ş

SİSTEM
**Senaryo Tip 21
 L-ION EP 44**

TARİH: 23.11.2018
 REV.NO: R02
 ÇİZEN: AYSUN VAYIÇ

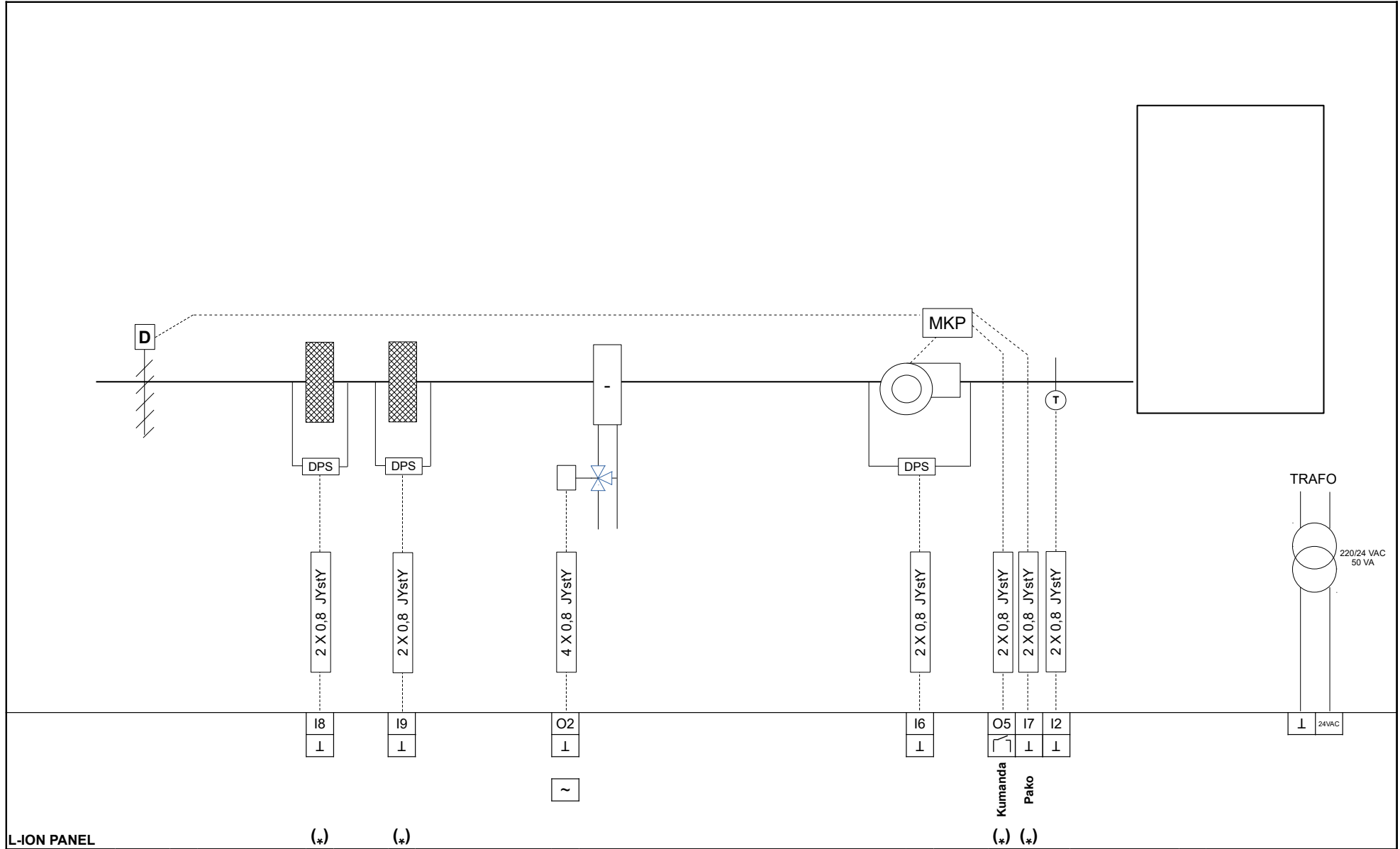

NOTLAR :

1-(*) İşaretili giriş/çıkışlar L-ION EP33 modelinde yoktur.

2-Röle çıkışlar 24VAC 5A'dir.



TEL: 0216 527 98 70
 FAX: 0216 527 98 71
 INTERNET: www.ontrol.com.tr

PROJE **ONTROL A.Ş**

SİSTEM **Senaryo Tip 22
 L-ION EP 44**

TARİH 23.11.2018
 REV.NO R02
 ÇİZEN AYSUN VAYIÇ



TEL: 0216 527 98 70
 FAX: 0216 527 98 71
 İNTERNET: www.ontrol.com.tr

PROJE **ONTROL A.Ş**

SİSTEM **Eşanjör Tip 23
 L-ION EP 44**

TARİH 23.11.2018
 REV.NO R02
 ÇİZEN AYSUN VAYIÇ

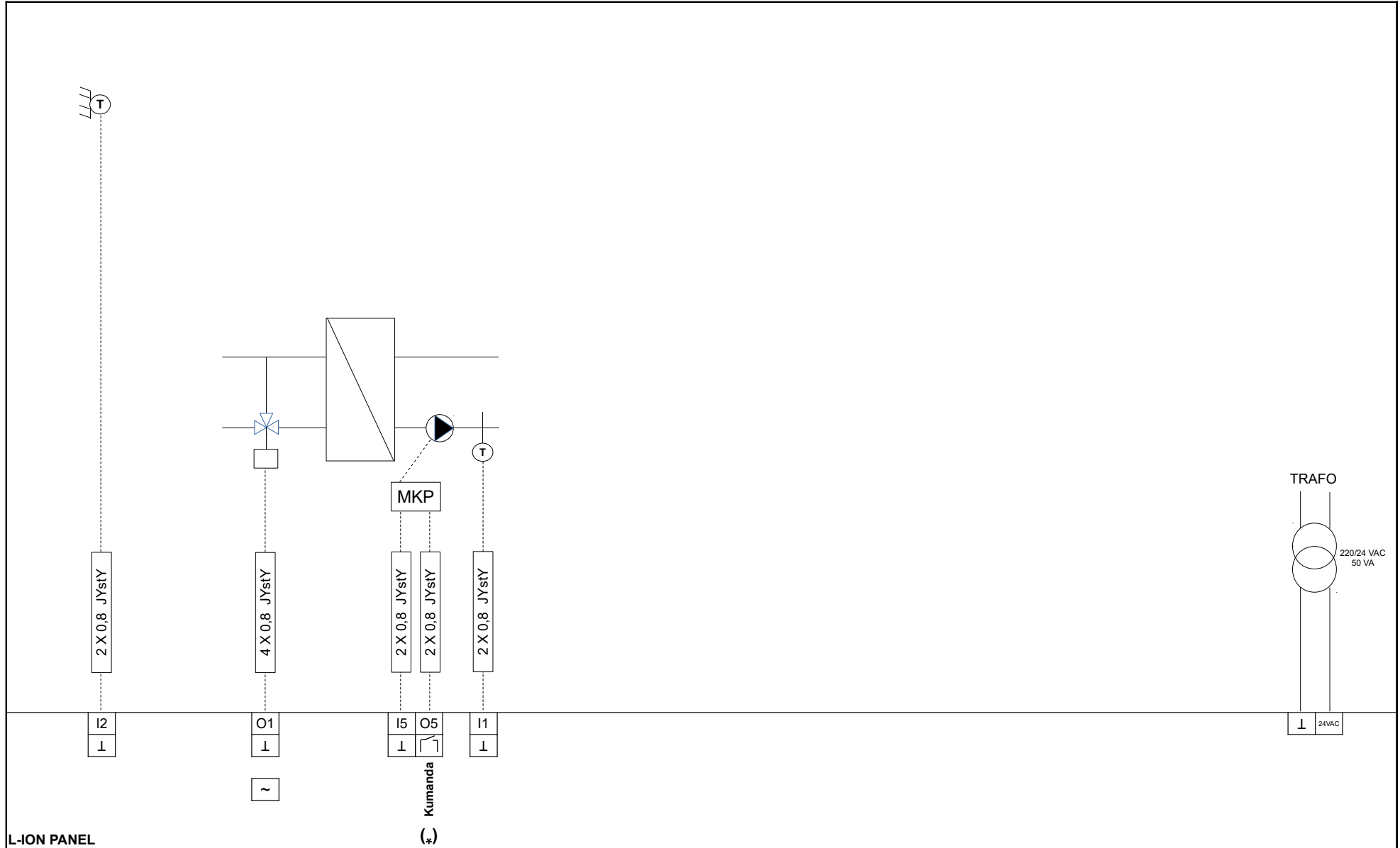

TEL: 0216 527 98 70
 FAX: 0216 527 98 71
 İNTERNET: www.ontrol.com.tr

PROJE
ONTROL A.Ş

SİSTEM
**Eşanjör Tip 24
 L-ION EP 44**

TARİH 23.11.2018
 REV.NO R02
 ÇİZEN AYSUN VAYIÇ

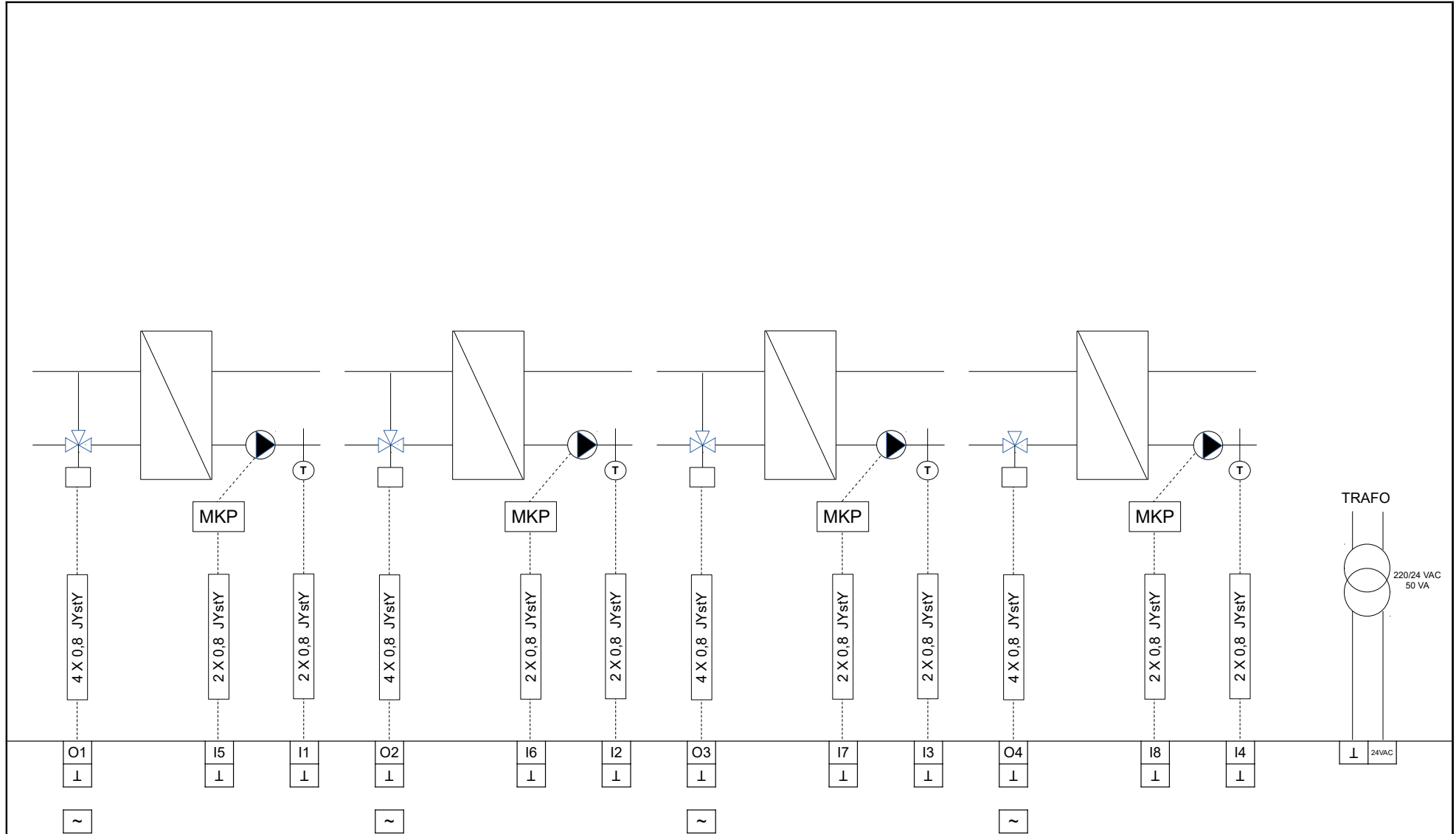

L-ION PANEL

NOTLAR :

1-(*) İşaretili giriş/çıkışlar L-ION EP33 modelinde yoktur.

2-Röle çıkışlar 24VAC 5A'dır.

	TEL: 0216 527 98 70	PROJE ONTROL A.Ş	SİSTEM Eşanjör Tip 25 L-ION EP 44	TARİH: 23.11.2018
	FAX: 0216 527 98 71			REV.NO: R02
	INTERNET: www.ontrol.com.tr			ÇİZEN: AYSUN VAYIÇ

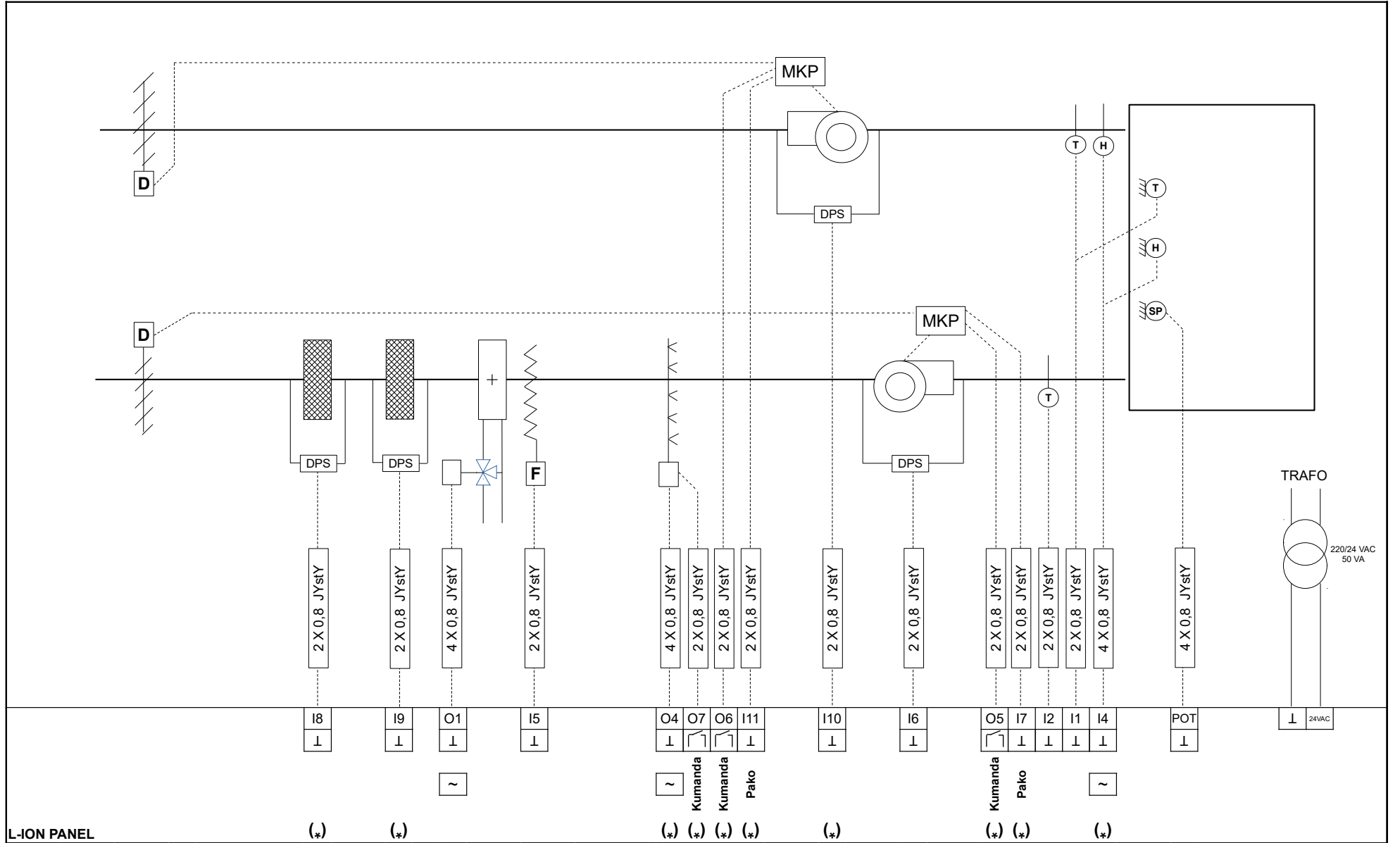

NOTLAR :

1-(*) İşaretili giriş/çıkışlar L-ION EP33 modelinde yoktur.

2-Röle çıkışlar 24VAC 5A'dir.



TEL: 0216 527 98 70
 FAX: 0216 527 98 71
 INTERNET: www.ontrol.com.tr

PROJE

ONTROL A.Ş

SİSTEM

Senaryo Tip 26
 L-ION EP 44

TARİH 23.11.2018

REV.NO R02

ÇİZEN AYŞUN VAYIÇ

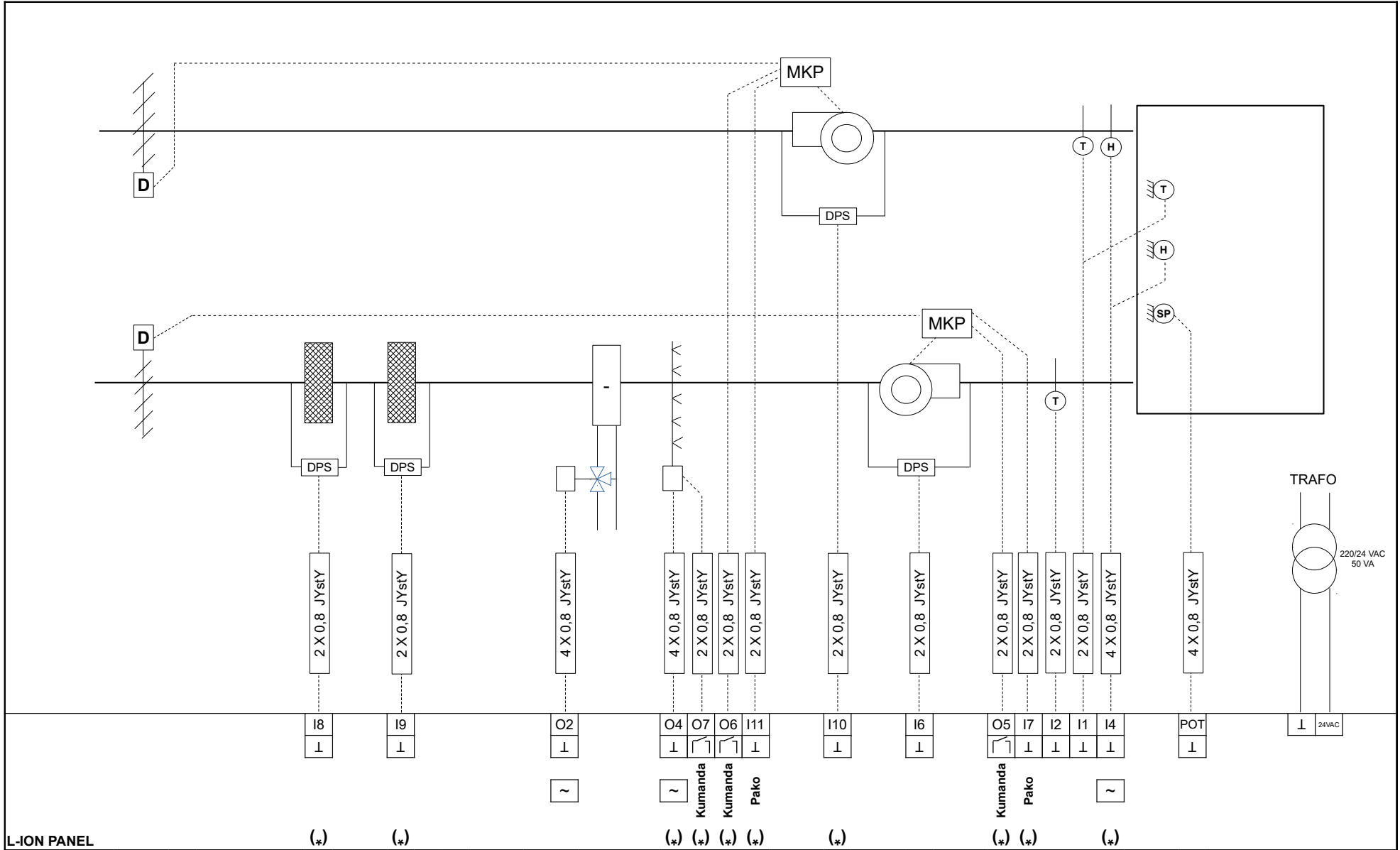

L-ION PANEL

(*)

(*)

(*)

(*)

(*)

(*)

(*)

(*)

(*)

(*)

NOTLAR :

1-(*) İşaretili giriş/çıkışlar L-ION EP33 modelinde yoktur.

2-Röle çıkışlar 24VAC 5A'dir.



TEL: 0216 527 98 70
FAX: 0216 527 98 71
INTERNET: www.ontrol.com.tr

PROJE

ONTROL A.Ş

SİSTEM

Senaryo Tip 27
L-ION EP 44

TARİH 23.11.2018

REV.NO R02

ÇİZEN AYSUN VAYIÇ

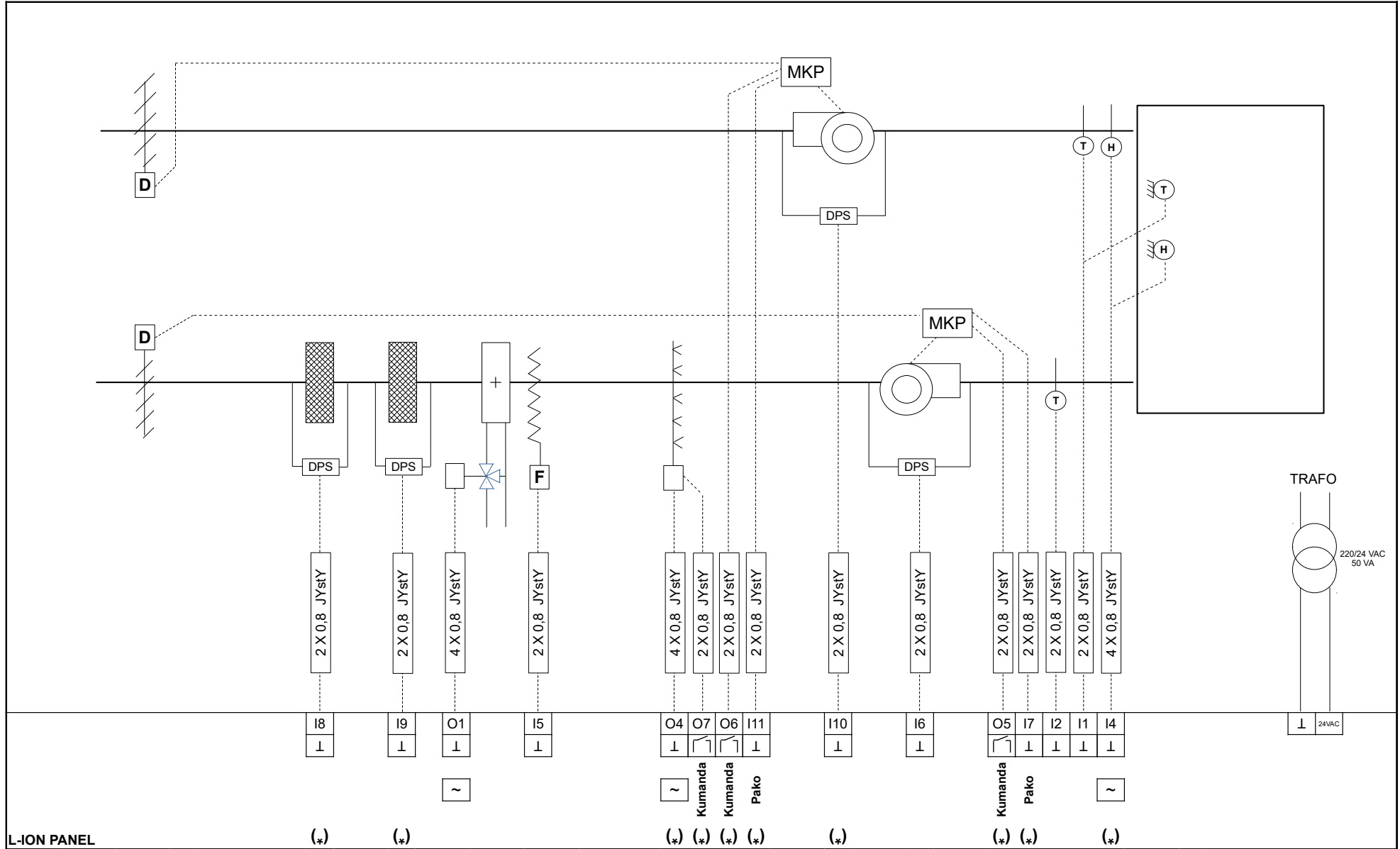

NOTLAR :

1-(*) İşaretili giriş/çıkışlar L-ION EP33 modelinde yoktur.

2-Röle çıkışlar 24VAC 5A'dir.



TEL: 0216 527 98 70
 FAX: 0216 527 98 71
 INTERNET: www.ontrol.com.tr

PROJE

ONTROL A.Ş

SİSTEM

Senaryo Tip 28
 L-ION EP 44

TARİH 23.11.2018

REV.NO R02

ÇİZEN AYSUN VAYIÇ

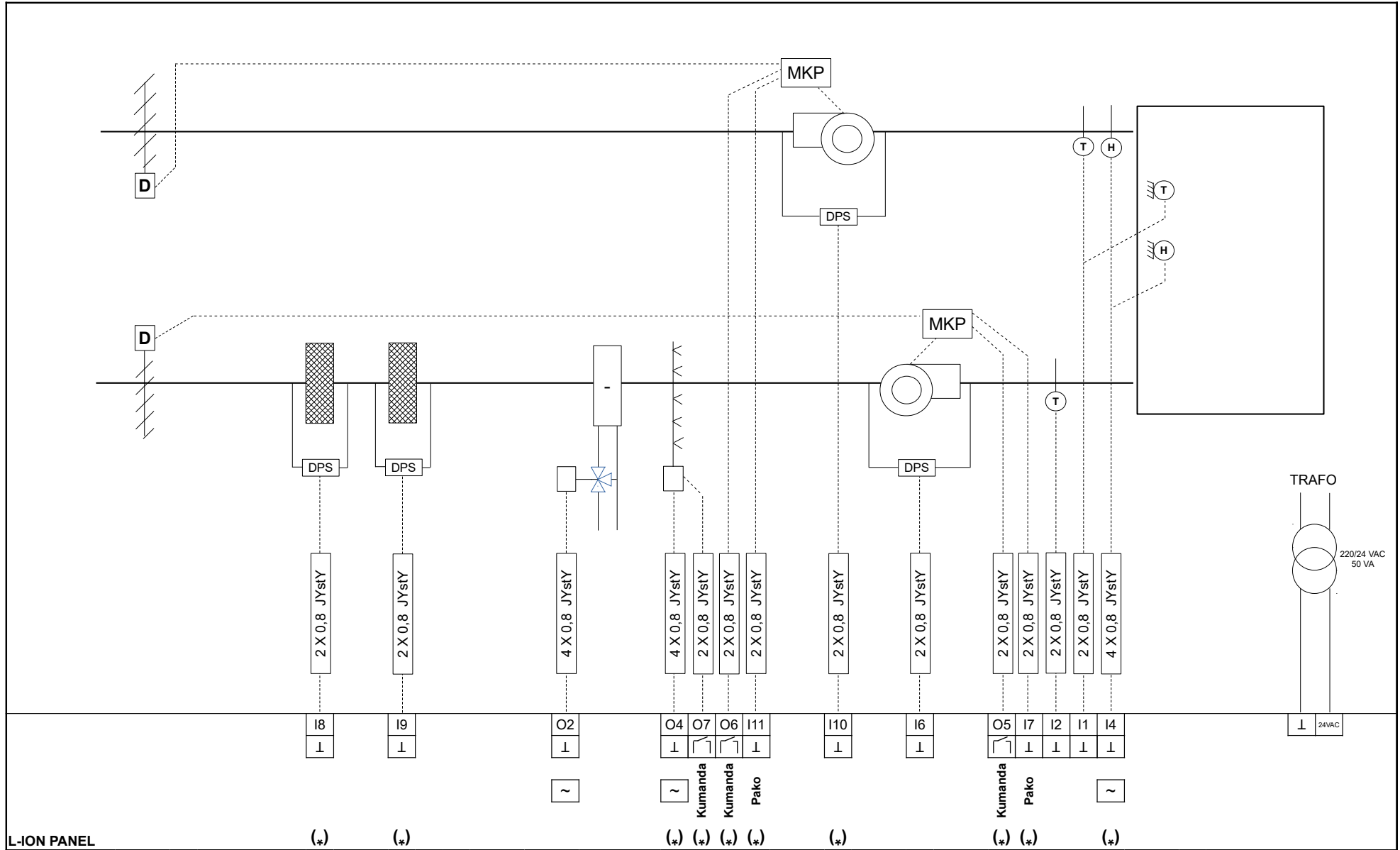

NOTLAR :

1-(*) İşaretili giriş/çıkışlar L-ION EP33 modelinde yoktur.

2-Röle çıkışlar 24VAC 5A'dir.



TEL: 0216 527 98 70
 FAX: 0216 527 98 71
 INTERNET: www.ontrol.com.tr

PROJE

ONTROL A.Ş

SİSTEM

**Senaryo Tip 29
 L-ION EP 44**

TARİH 23.11.2018

REV.NO R02

ÇİZEN AYSUN VAYIÇ

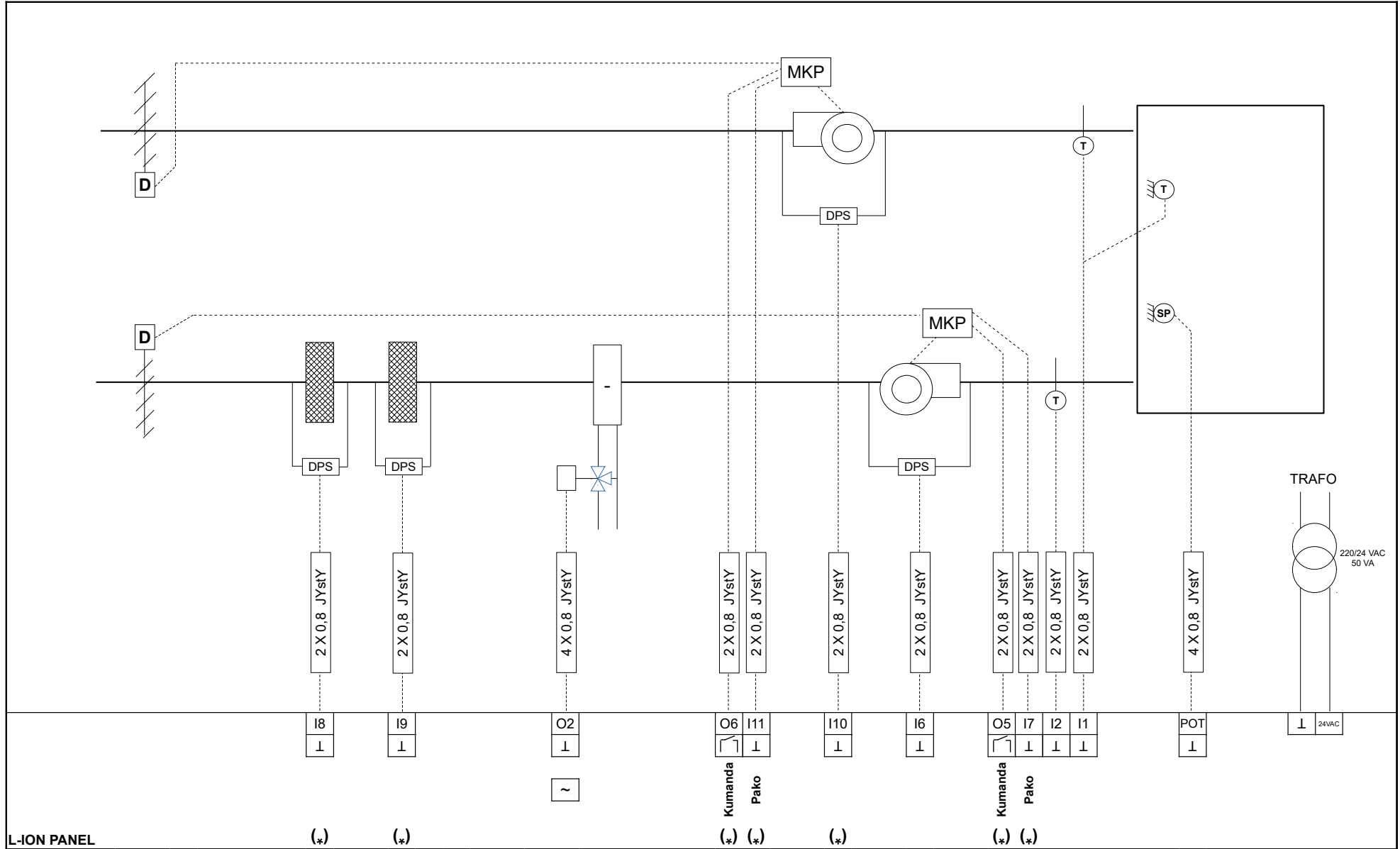

NOTLAR :

1-(*) İşaretili giriş/çıkışlar L-ION EP33 modelinde yoktur.

2-Röle çıkışlar 24VAC 5A'dir.



TEL: 0216 527 98 70
 FAX: 0216 527 98 71
 İNTERNET: www.ontrol.com.tr

PROJE
ONTROL A.Ş

SİSTEM
**Senaryo Tip 31
 L-ION EP 44**

TARİH 23.11.2018
 REV.NO R02
 ÇİZEN AYSUN VAYIÇ

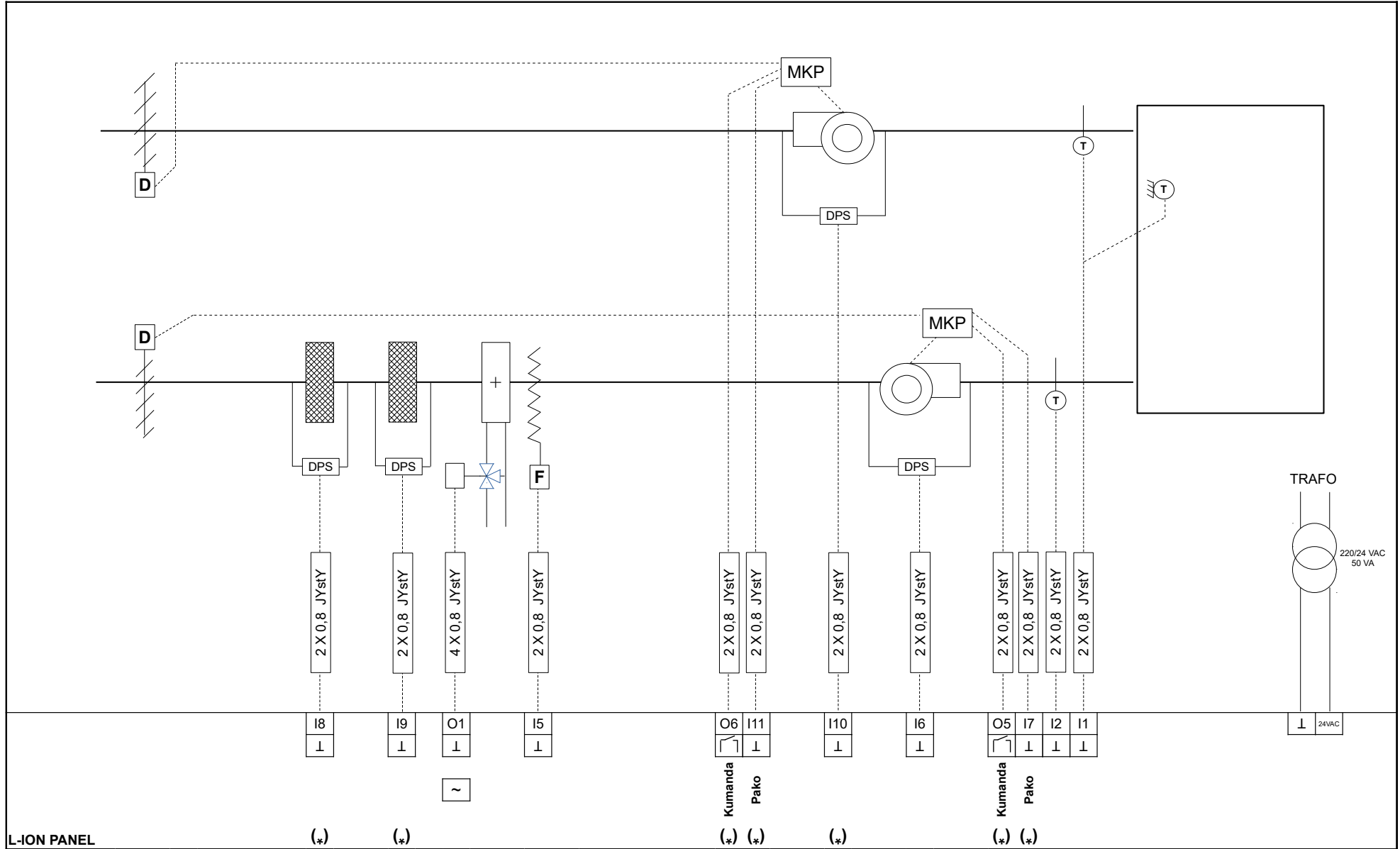

NOTLAR :

1-(*) İşaretili giriş/çıkışlar L-ION EP33 modelinde yoktur.

2-Röle çıkışlar 24VAC 5A'dır.



TEL: 0216 527 98 70
 FAX: 0216 527 98 71
 INTERNET: www.ontrol.com.tr

PROJE
ONTROL A.Ş

SİSTEM
**Senaryo Tip 32
 L-ION EP 44**

TARİH: 23.11.2018
 REV.NO: R02
 ÇİZEN: AYSUN VAYIÇ

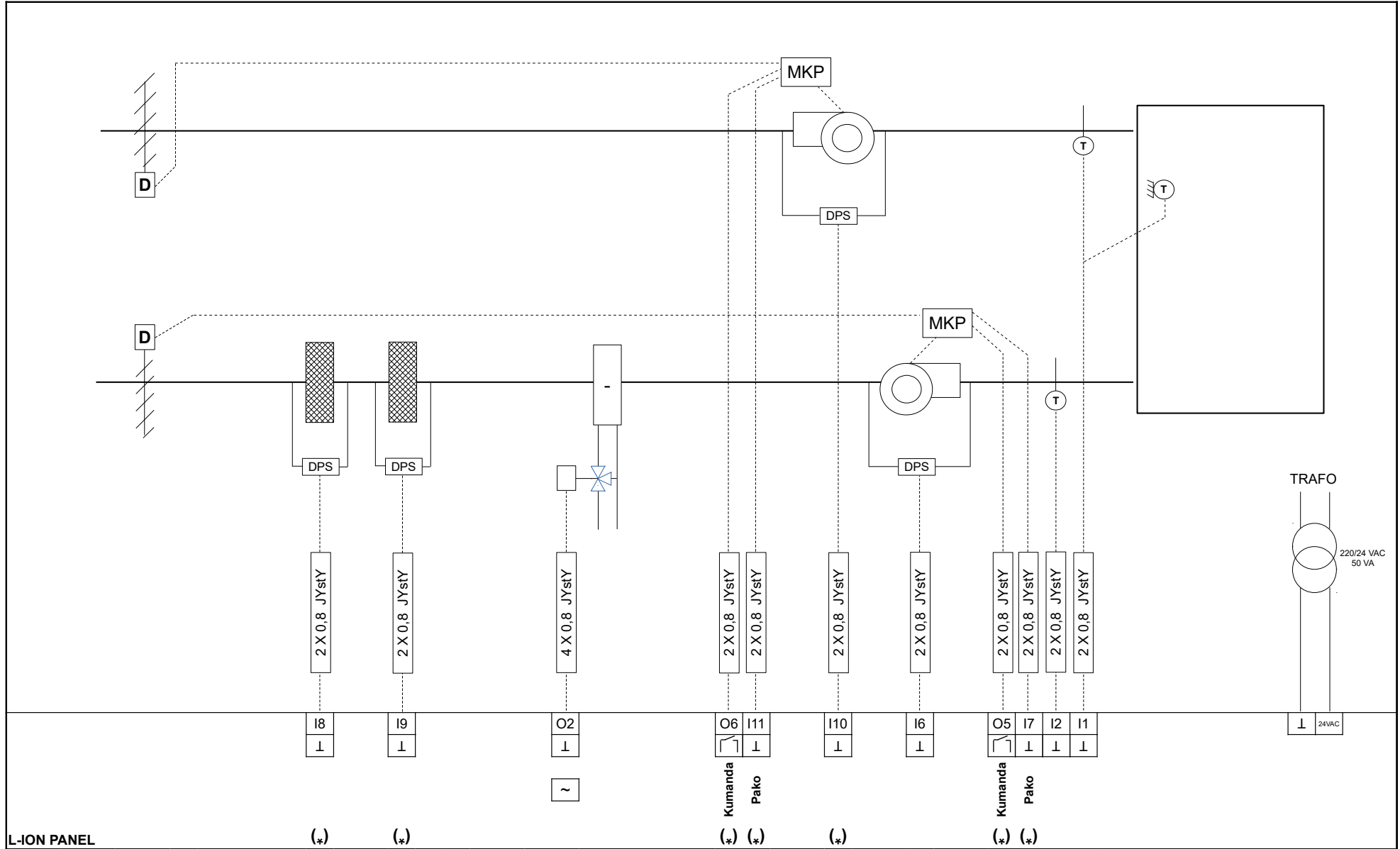

NOTLAR :

1-(*) İşaretili giriş/çıkışlar L-ION EP33 modelinde yoktur.

2-Röle çıkışlar 24VAC 5A'dir.



TEL: 0216 527 98 70
 FAX: 0216 527 98 71
 INTERNET: www.ontrol.com.tr

PROJE
ONTROL A.Ş

SİSTEM
**Senaryo Tip 33
 L-ION EP 44**

TARİH: 23.11.2018
 REV.NO: R02
 ÇİZEN: AYSUN VAYIÇ

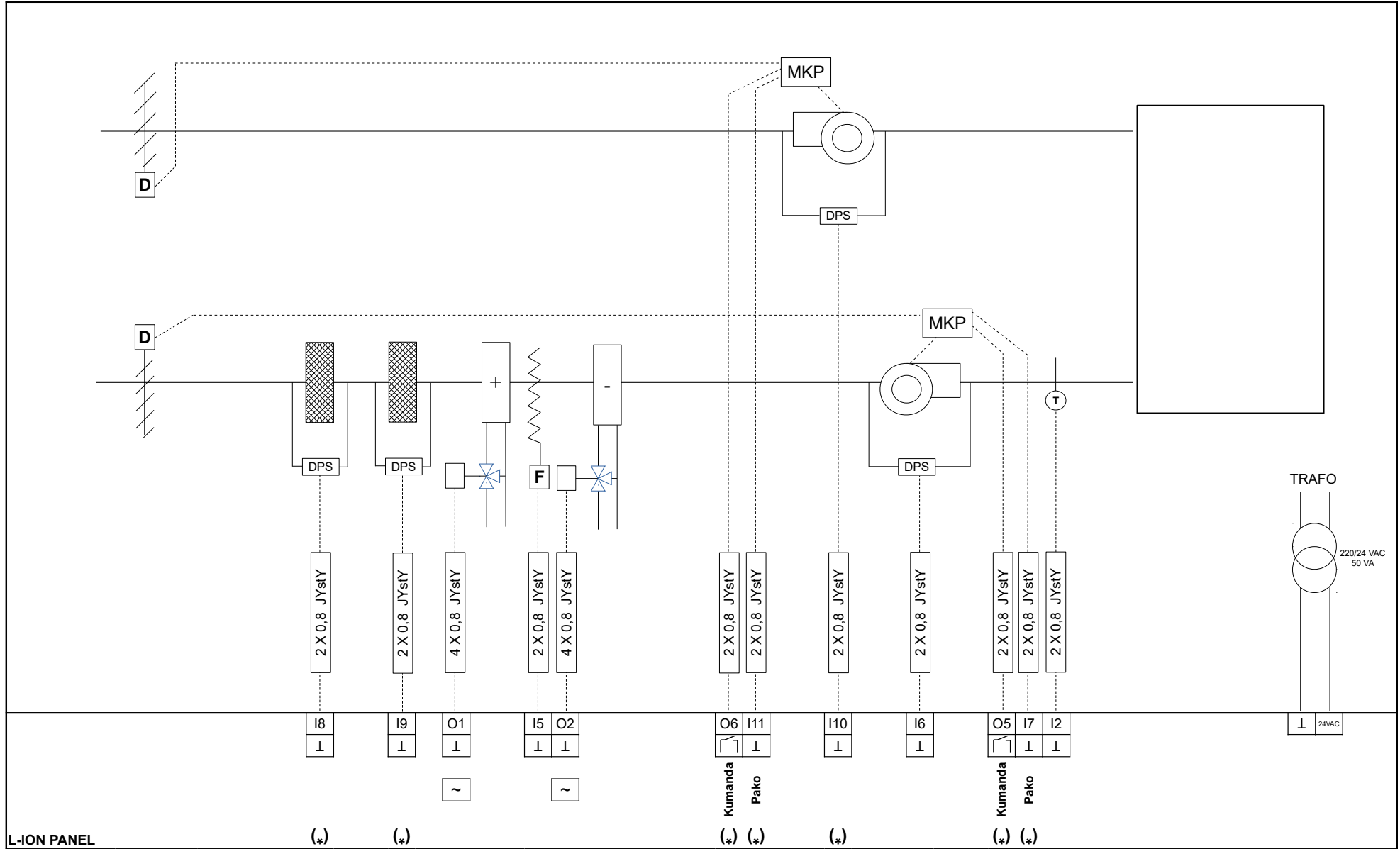

NOTLAR :

1-(*) İşaretili giriş/çıkışlar L-ION EP33 modelinde yoktur.

2-Röle çıkışlar 24VAC 5A'dır.



TEL: 0216 527 98 70
 FAX: 0216 527 98 71
 INTERNET: www.ontrol.com.tr

PROJE
ONTROL A.Ş

SİSTEM
**Senaryo Tip 34
 L-ION EP 44**

TARİH: 23.11.2018
 REV.NO: R02
 ÇİZEN: AYSUN VAYIÇ

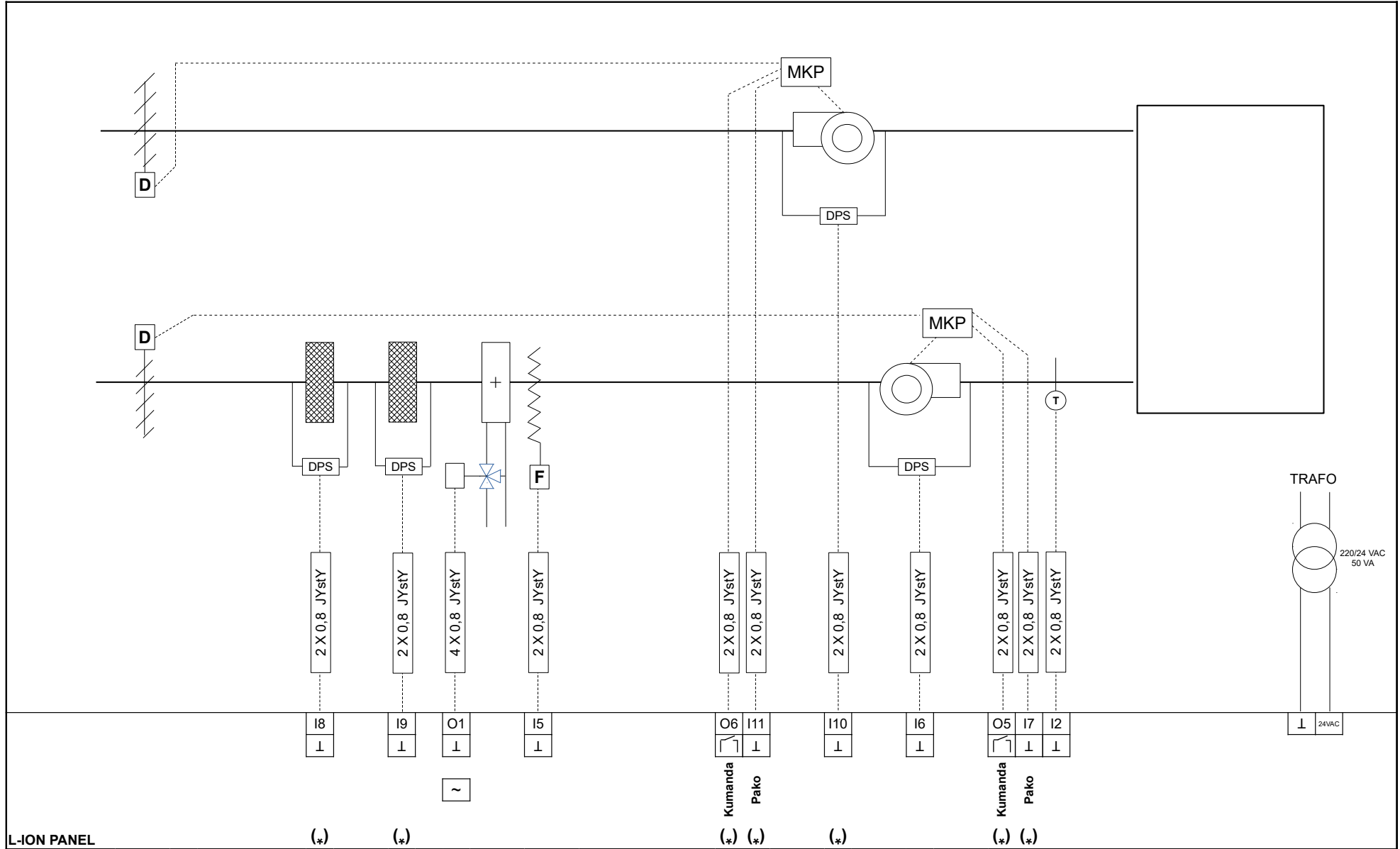

L-ION PANEL

NOTLAR :

1-(*) İşaretili giriş/çıkışlar L-ION EP33 modelinde yoktur.

2-Röle çıkışlar 24VAC 5A'dir.



TEL: 0216 527 98 70
 FAX: 0216 527 98 71
 INTERNET: www.ontrol.com.tr

PROJE

ONTROL A.Ş

SİSTEM

Senaryo Tip 35
 L-ION EP 44

TARİH 23.11.2018

REV.NO R02

ÇİZEN AYSUN VAYIÇ

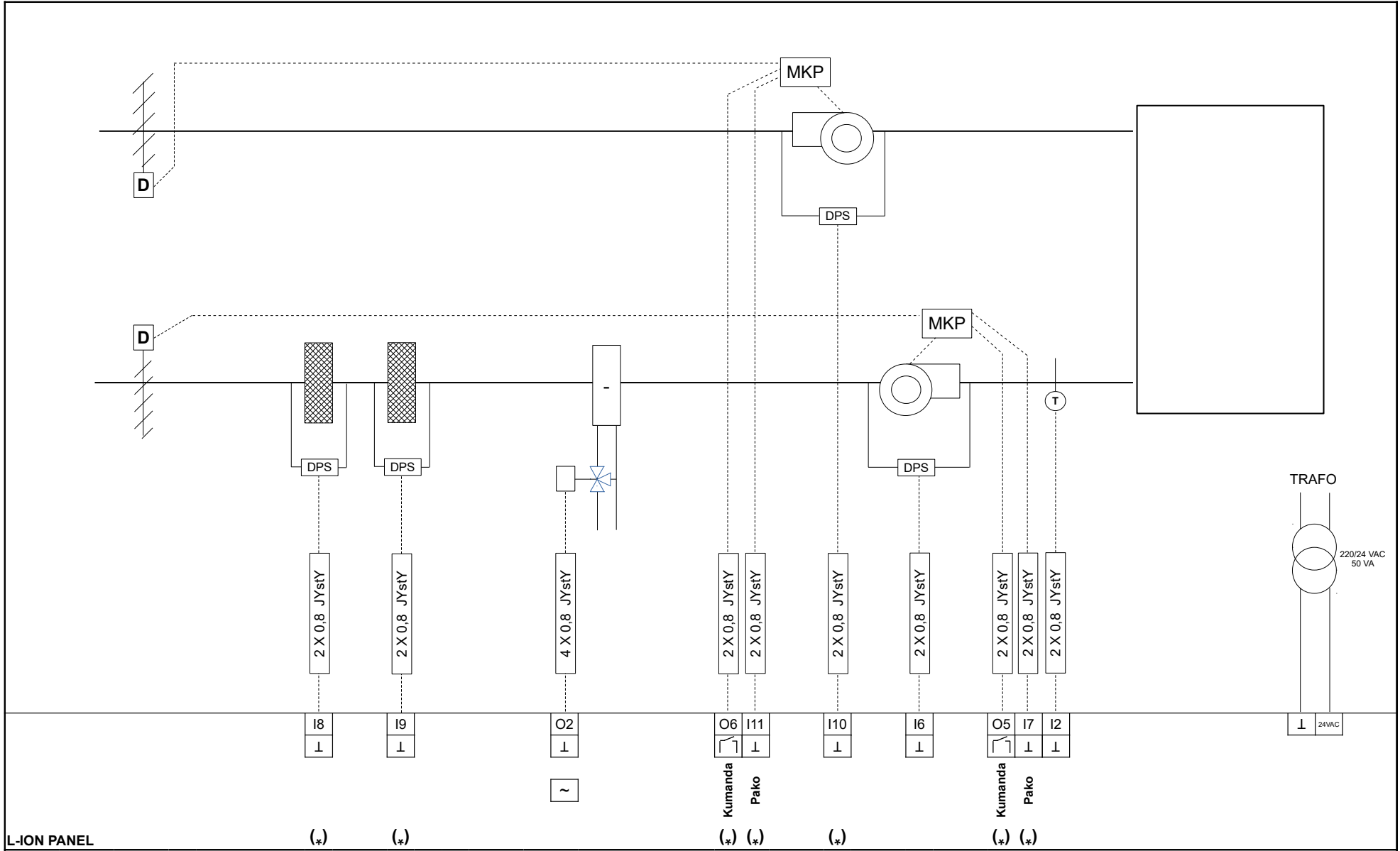

NOTLAR :

1-(*) İşaretili giriş/çıkışlar L-ION EP33 modelinde yoktur.

2-Röle çıkışlar 24VAC 5A'dir.



TEL: 0216 527 98 70
 FAX: 0216 527 98 71
 INTERNET: www.ontrol.com.tr

PROJE
ONTROL A.Ş

SİSTEM
**Senaryo Tip 36
 L-ION EP 44**

TARİH 23.11.2018
 REV.NO R02
 ÇİZEN AYSUN VAYIÇ